

MIXING CONSOLE

GF12₁₂/GF16₁₂/GF24₁₂

SERVICE MANUAL



■ CONTENTS

SPECIFICATIONS	3/4
PANEL LAYOUT	5
DIMENSIONS	8
BLOCK & LEVEL DIAGRAM	9
CIRCUIT BOARD LAYOUT	10
WIRING	11
DISASSEMBLY PROCEDURE	12
IC BLOCK DIAGRAM	17
CIRCUIT BOARDS	18
INSPECTIONS	26
PARTS LIST	
CIRCUIT DIAGRAM	

IMPORTANT NOTICE

This manual has been provided for the use of authorized Yamaha Retailers and their service personnel. It has been assumed that basic service procedures inherent to the industry, and more specifically Yamaha Products, are already known and understood by the users, and have therefore not been restated.

WARNING : Failure to follow appropriate service and safety procedures when servicing this product may result in personal injury, destruction of expensive components and failure of the product to perform as specified. For these reasons, we advise all Yamaha product owners that all service required should be performed by an authorized Yamaha Retailer or the appointed service representative.

IMPORTANT : This presentation or sale of this manual to any individual or firm does not constitute authorization certification, recognition of any applicable technical capabilities, or establish a principal-agent relationship of any form.

The data provided is believed to be accurate and applicable to the unit(s) indicated on the cover. The research engineering, and service departments of Yamaha are continually striving to improve Yamaha products. Modifications are, therefore, inevitable and changes in specification are subject to change without notice or obligation to retrofit. Should any discrepancy appear to exist, please contact the distributor's Service Division.

WARNING : Static discharges can destroy expensive components. Discharge any static electricity your body may have accumulated by grounding yourself to the ground buss in the unit (heavy gauge black wires connect to this buss.)

IMPORTANT : Turn the unit OFF during disassembly and parts replacement. Recheck all work before you apply power to the unit.

LITHIUM BATTERY HANDLING

This product uses a lithium battery for memory back-up.

WARNING : Lithium batteries are dangerous because they can be exploded by improper handling. Observe the following precautions when handling or replacing lithium batteries.

- Leave lithium battery replacement to qualified service personnel.
- Always replace with batteries of the same type.
- When installing on the PC board by soldering, solder using the connection terminals provided on the battery cells.
- Never solder directly to the cells. Perform the soldering as quickly as possible.
- Never reverse the battery polarities when installing.
- Do not short the batteries.
- Do not attempt to recharge these batteries.
- Do not disassemble the batteries.
- Never heat batteries or throw them into fire.

ADVARSEL!

Lithiumbatteri-Eksplosionsfare ved fejlagtig handling. Udskiftning må kun ske med batteri af samme fabrikat og type. lever det brugte batteri tilbage til leverandren.

VARNING

Explosionsfara vid felaktigt batteribyte.

Använd samma batterityp eller en ekvivalent typ som rekommenderas av apparattillverkaren.

Kassera anvant batteri enligt fabrikantens instruktion.

VAROITUS

Paristo voi rajahtaa, jos se on virheellisesti asennettu.

Vaihda paristo ainoastaan laitevalmistajan suosittelemaan tyyppiin.

Havita käytetty paristo valmistajan ohjeiden mukaisesti.

The following information complies with Dutch official Gazette 1995. 45; ESSENTIALS OF ORDER ON THE COLLECTION OF BATTERIES.

- Please refer to the disassembly procedure for the removal of Back-up Battery.
- Leest u voor het verwijderen van de backup batterij deze beschrijving.

WARNING: CHEMICAL CONTENT NOTICE!

The solder used in the production of this product contains LEAD. In addition, other electrical/electronic and/or plastic (Where applicable) components may also contain traces of chemicals found by the California Health and Welfare Agency (and possibly other entities) to cause cancer and/or birth defects or other reproductive harm.

DO NOT PLACE SOLDER, ELECTRICAL/ELECTRONIC OR PLASTIC COMPONENTS IN YOUR MOUTH FOR ANY REASON WHAT SO EVER!

Avoid prolonged, unprotected contact between solder and your skin! When soldering, do not inhale solder fumes or expose eyes to solder/flux vapor!

If you come in contact with solder or components located inside the enclosure of this product, wash your hands before handling food.

■ WARNING

Components having special characteristics are marked  and must be replaced with parts having specification equal to those originally installed.

SPECIFICATIONS

General specifications

Frequency response	20 Hz-20 kHz ± 1 dB, -2 dB @ ± 1 dB into 600 ohm (GROUP OUT, AUX OUT, ST OUT, MONO OUT)	Input gain control: minimum
Total harmonic distortion	Less than 0.1% @20 Hz-20 kHz, ± 14 dB into 600 ohm (GROUP OUT, AUX OUT, ST OUT, MONO OUT)	
Hum & noise (Average, RS=150A with 20 Hz-20 kHz BPF)	-129 dB equivalent input noise (GROUP OUT, AUX OUT, ST OUT, MONO OUT)	Master fader, nominal level
	-95 dB residual output noise (GROUP OUT, AUX OUT, ST OUT, MONO OUT)	All channel faders, minimum
Hum & noise (Average, RS=150A with 20 Hz-20 kHz BPF)	-86 dB (GROUP OUT, ST OUT, MONO OUT)	All channel assign switches, off
	-81 dB (AUX OUT)	Master fader, nominal level
Maximum voltage gain	-64 dB (68 dB SN) (GROUP OUT, AUX OUT, ST OUT)	Master fader, one channel fader, assign switch on, AUX level control: nominal level
	84 dB CH IN to ST OUT 84 dB CH IN to GROUP OUT 59 dB ST IN to ST OUT 59 dB ST IN to GROUP OUT	All channel faders, all AUX level controls: minimum
Crossstalk (at 1 kHz)	70 dB adjacent input 70 dB input to output	Master fader, one channel fader, assign switch on, AUX level control: maximum
CH input gain control	44 dB variable	
CH input PAD	0 dB/26 dB	
CH input HPF	80 Hz 12 dB/oct	
CH input equalization	± 15 dB maximum HIGH 10 kHz shelving* MID 250 Hz-5 kHz peaking LOW 100 Hz shelving*	
	* Turn over/off of frequency of shelving, 3 dB below maximum variable level	
	± 15 dB maximum HIGH 10 kHz shelving* MID 2.5 kHz peaking LOW 100 Hz shelving*	
	* Turn over/off of frequency of shelving, 3 dB below maximum variable level	
Meters	13 points LED meters x4 (GROUP 1-4/ST 1, R, PFL, AFL, TAPE IN, L, R)	
CH peak indicators	Red LED on each channel turns on when Post EQ signal reaches the level -3 dB below clipping.	
Phantom power	± 48 Vts supplied to electrically balanced inputs.	
Power requirement	USA and Canada: 230 V AC 50 Hz Other:	
Power consumption	GF24/12: 70 W, GF16/12: 70 W, GF12/12: 70 W	
Dimensions (WxHxD)	GF24/12: 938x157x487 mm GF16/12: 701x157x487 mm GF12/12: 587x157x487 mm	
Weight	GF24/12: 20 kg, GF16/12: 18 kg, GF12/12: 14 kg	

* 0 dB is referenced to 0.775 Vrms.

Input specifications

Input terminals	Gain trim	Actual load impedance	For use with nominal	Input level		Connector
				Sensitivity ^{f1}	Nominal	
INPUT A, B (1-20, 1-12, 1-8)	MAX	3 kohm	50-600 ohm Mics	-86 dB (38.8 mV)	-50 dB (0.775 mV)	A: XLR-3 pin type ^{f2}
				-42 dB (6.16 mV)	-16 dB (1.23 mV)	B: Phone jack ^{f3}
ST INPUT A, B (21-24, 13-16, 9-12)	MAX	10 kohm	600 ohm Lines	-60 dB (0.775 mV)	-34 dB (16.6 mV)	A: Phone jack ^{f3}
				-16 dB (123 mV)	$+10$ dB (2.46 V)	B: Phone jack ^{f3}
AUX RTR IN (L, R)	MIN	10 kohm	600 ohm Lines	-12 dB (195 mV)	$+4$ dB (1.23 V)	Phone jack ^{f3}
				-26 dBV (60.1 mV)	-10 dBV (0.18 mV)	Phone jack ^{f3}
TAPE IN (L, R)	MIN	10 kohm	600 ohm Lines	-28 dB (38.8 mV)	0 dB (775 mV)	Phone jack ^{f3}
				-10 dB (246 mV)	0 dB (775 mV)	Phone jack ^{f3}
CH INSERT IN		10 kohm	600 ohm Lines	-28 dB (38.8 mV)	0 dB (775 mV)	Phone jack ^{f3}
ST INSERT IN (L, R)		10 kohm	600 ohm Lines	-10 dB (246 mV)	$+20$ dB (7.75 V)	Phone jack ^{f3}

^{f1} Sensitivity is the lowest level that will produce an output of ± 4 dB (1.23 V) or the nominal output level when the unit is set at maximum gain. (All faders and level controls are at maximum positions)

^{f2} Balanced

^{f3} Unbalanced

* When dB represents a specific voltage, 0 dB is referenced to 0.775 Vrms, 0 dBV is referenced to 1 Vrms.

Output specifications

Output terminals	Actual source impedance	For use with nominal	Output level		Connector
			Nominal	Max. before clip	
ST OUT (L, R)	150 ohm	600 ohm Lines	± 4 dB (1.23 V)	± 24 dB (12.3 V)	XLR-3 pin type ^{f1}
MONO OUT	150 ohm	600 ohm Lines	± 4 dB (1.23 V)	± 24 dB (12.3 V)	
GROUP OUT (1-4)	75 ohm	600 ohm Lines	± 4 dB (1.23 V)	± 20 dB (7.75 V)	Phone jack ^{f2}
AUX OUT (1-8)	150 ohm	600 ohm Lines	± 4 dB (1.23 V)	± 24 dB (12.3 V)	Phone jack ^{f1}
C-R OUT (L, R)	75 ohm	600 ohm Lines	± 4 dB (1.23 V)	± 20 dB (7.75 V)	Phone jack ^{f2}
REC OUT (L, R)	600 ohm	10 kohm Lines	-10 dBV (3.16 mV)	± 10 dBV (3.16 V)	Phone jack ^{f2}
CH INSERT OUT (1-20, 1-12, 1-8)	600 ohm	10 kohm Lines	0 dB (775 mV)	± 20 dB (7.75 V)	Phone jack (VO) ^{f2}
ST INSERT OUT (L, R)	600 ohm	10 kohm Lines	0 dB (775 mV)	± 20 dB (7.75 V)	
PHONES OUT	100 ohm	40 ohm Phones	3 mW	100 mW	ST Phone jack ^{f2}

^{f1} Balanced
^{f2} Unbalanced
* When dB represents a specific voltage, 0 dB is referenced to 0.775 Vrms, 0 dBV is referenced to 1 Vrms.

■ PANEL LAYOUT

● Front panel

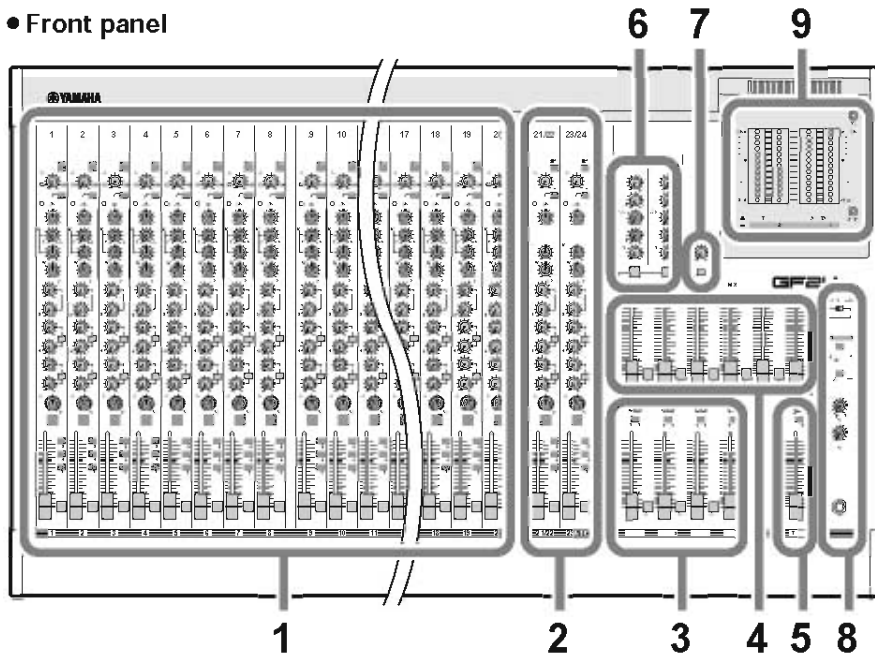

● Channel controls

1. Mono input channels (page 6)
2. Stereo input channels (page 6)

● Master controls

3. GROUP section (page 7)
4. AUX section (page 7)
5. STEREO/MONO section (page 7)
6. AUX RETURN section (page 7)
7. TAPE IN section (page 7)
8. Other controls/connectors (page 7)
9. Meter section (page 8)

● Rear panel

Connectors (page 8)

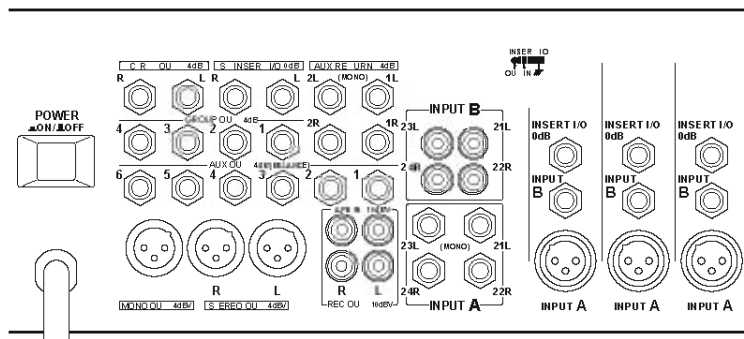

• Channel controls

1. Mono input channels

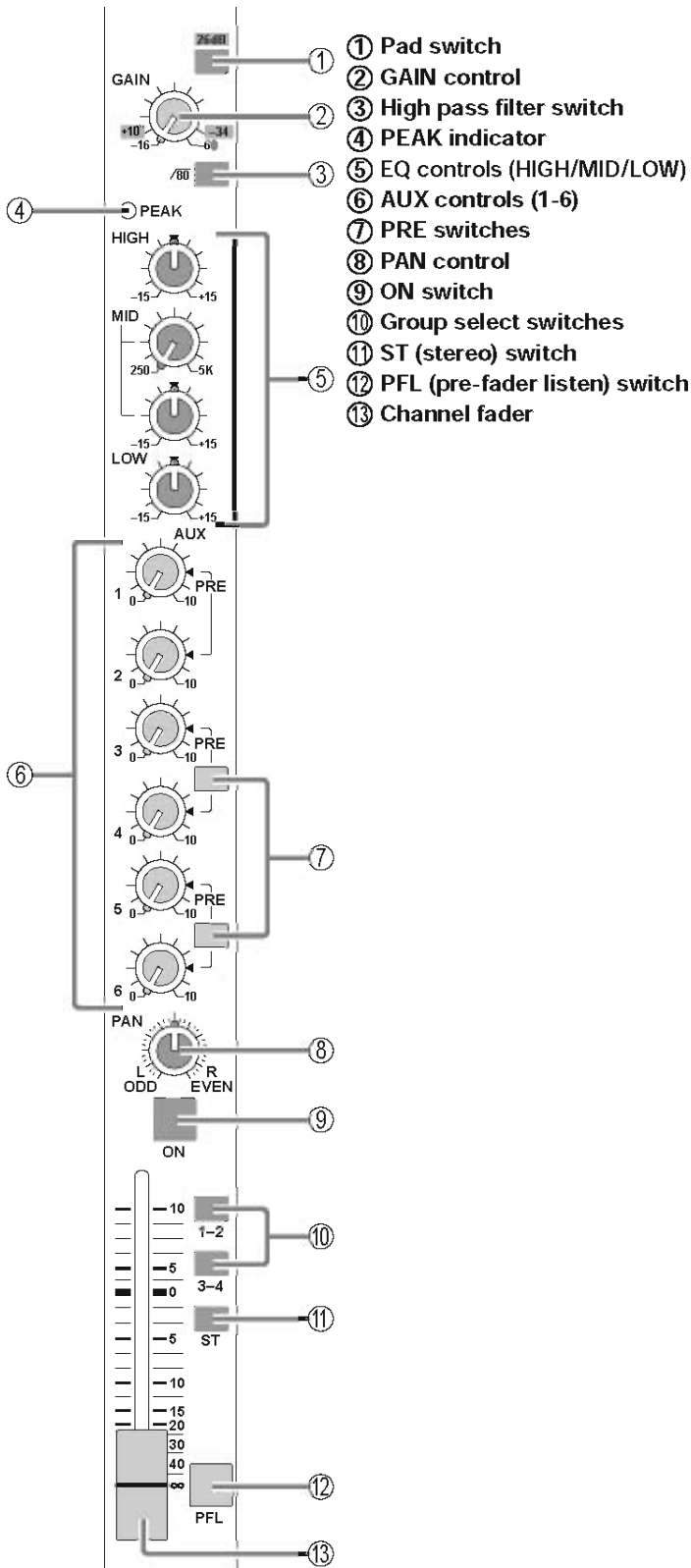

1. Stereo input channels

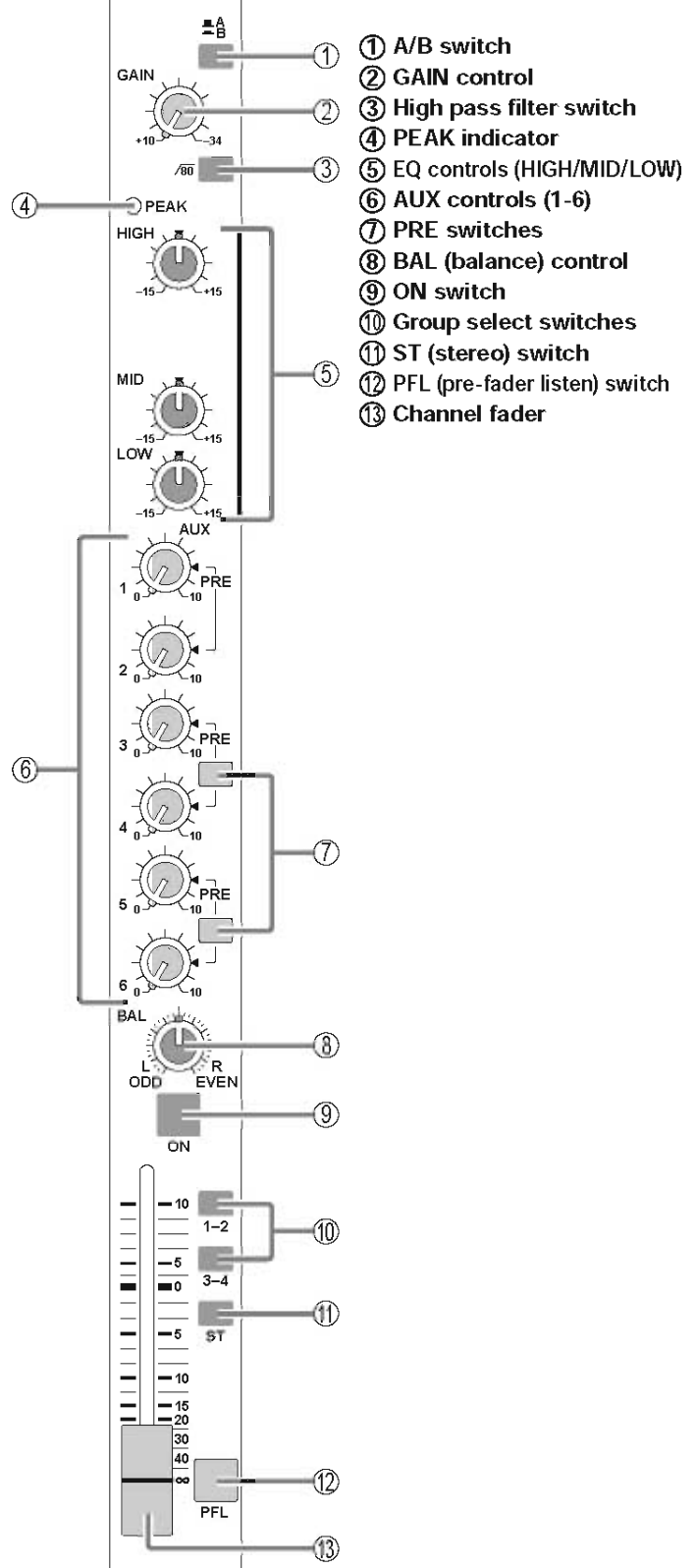

● Master controls

3. Group section

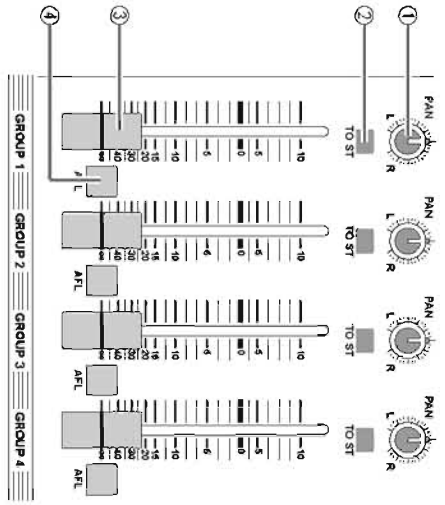

- ① PAN control
- ② TO ST switch
- ③ Group fader
- ④ AFL (after-fader listen) switch

5. STEREO/MONO section

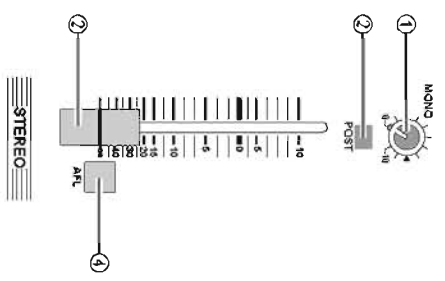

- ① MONO (monaural) control
- ② POST switch
- ③ STEREO fader
- ④ AFL (after-fader listen) switch

8. Other controls/connectors

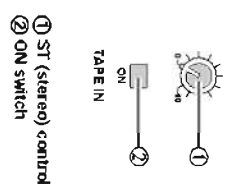

- ① ST (stereo) control
- ② ON switch

4. AUX section

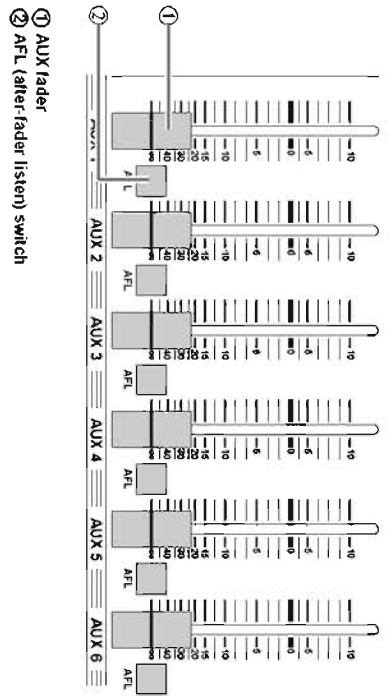

- ① AUX fader
- ② AFL (after-fader listen) switch

6. AUX RETURN section

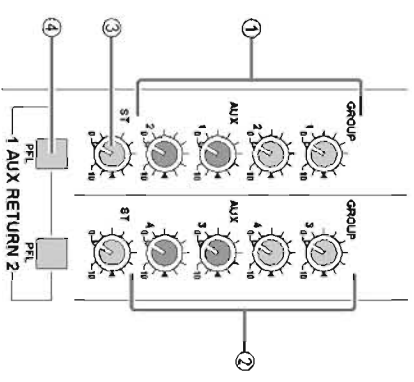

- ① GROUP 1/2, AUX 1/2 mix controls
- ② GROUP 3/4, AUX 3/4 mix controls
- ③ ST (stereo) controls
- ④ PFL (pre-fader listen) switch

7. TAPE IN section

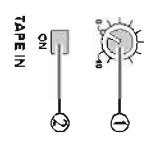

- ① ST (stereo) control
- ② ON switch

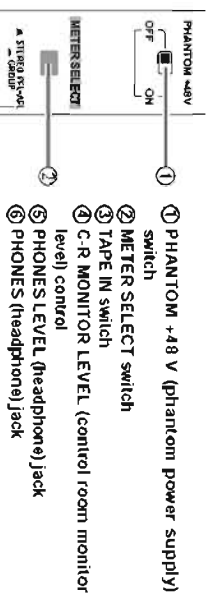

- ① PHANTOM +48 V (phantom power supply) switch
- ② METER SELECT switch
- ③ TAPE IN switch
- ④ C-R MONITOR LEVEL (control room monitor level) control
- ⑤ PHONES LEVEL (headphone) jack
- ⑥ PHONES (headphone) jack

9. Meter section

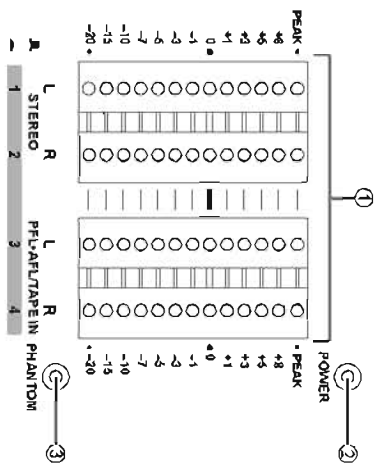

• Connectors

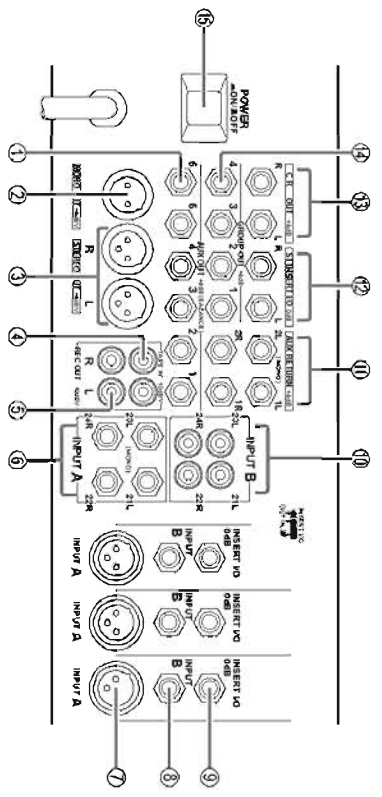

- ① AUX OUT jacks 1-6
- ② MONO OUT jack
- ③ STEREO OUT jacks
- ④ TAPE IN connector
- ⑤ REC OUT jacks
- ⑥ INPUT A jacks 21-24 (13-16 on the GF16/12, 9-12 on the GF12/12)
- ⑦ INPUT A jacks 1-20 (1-12 on the GF16/12, 1-8 on the GF12/12)
- ⑧ INPUT B jacks 1-20 (1-12 on the GF16/12, 1-8 on the GF12/12)
- ⑨ INSERT I/O jacks 1-20 (1-12 on the GF16/12, 1-8 on the GF12/12)
- ⑩ INPUT B jacks 21-24 (13-16 on the GF16/12, 9-12 on the GF12/12)
- ⑪ AUX RETURN jacks 1/2
- ⑫ ST INSERT I/O jacks
- ⑬ C-R OUT (control room monitor out) jacks
- ⑭ GROUP OUT jacks 1-4
- ⑮ POWER switch

■ DIMENSIONS

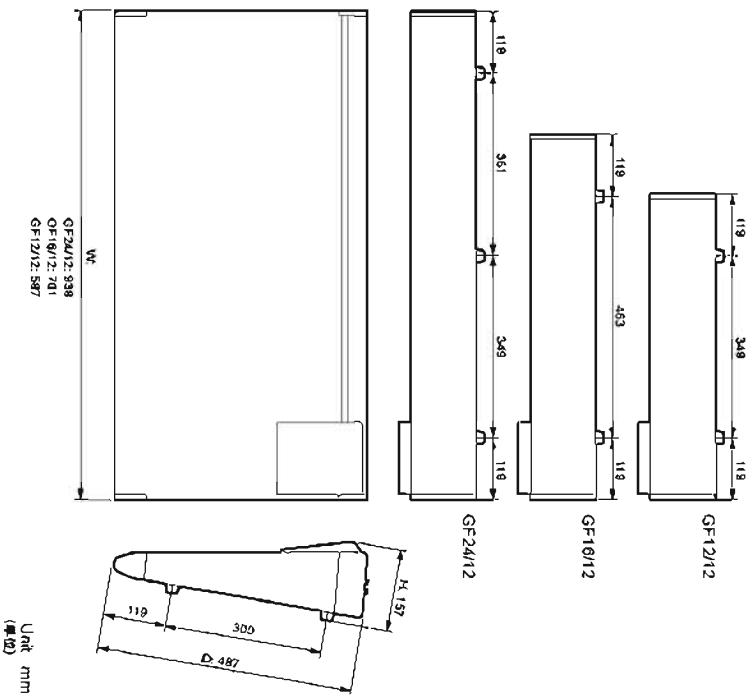

BLOCK & LEVEL DIAGRAM

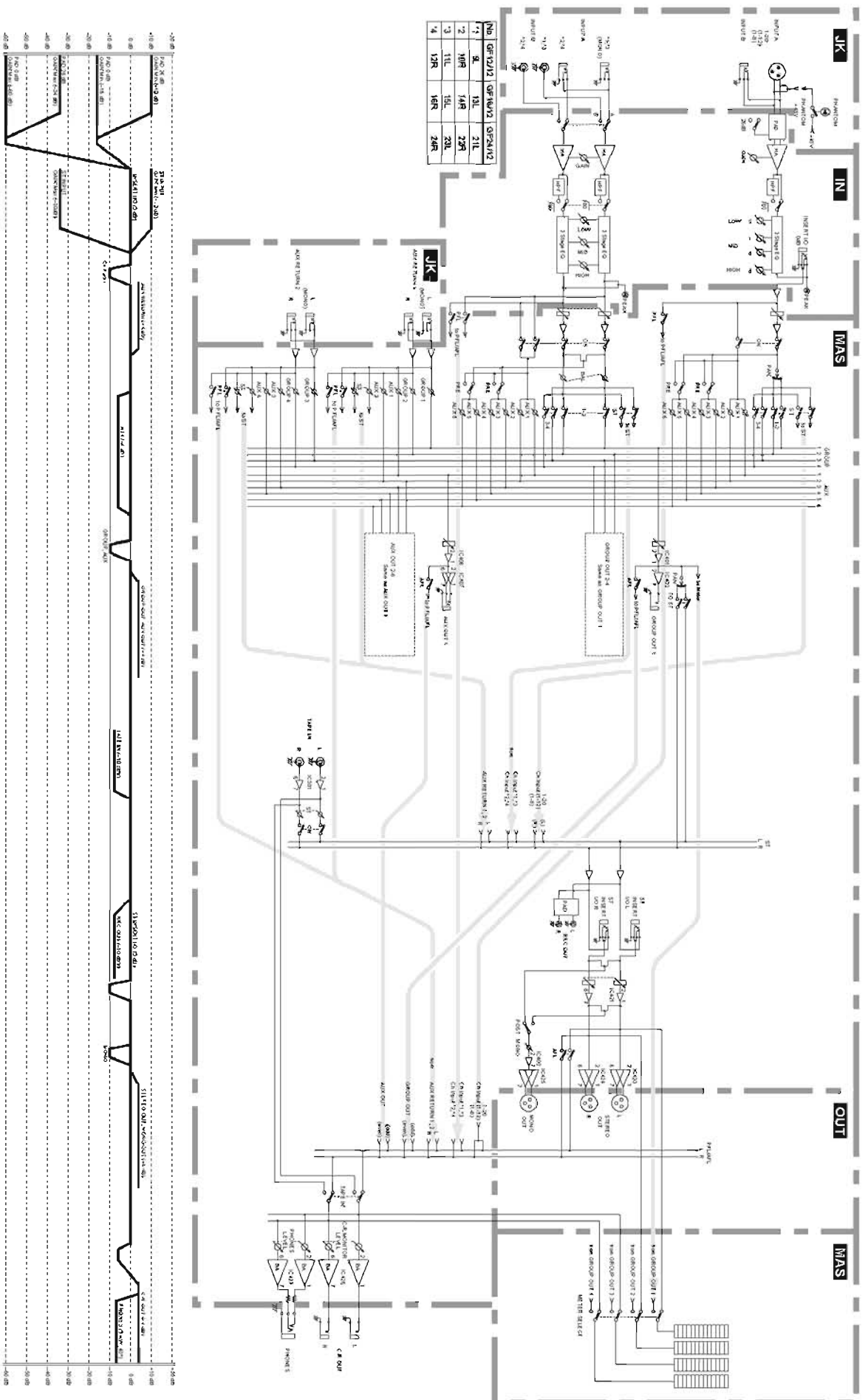

■ CIRCUIT BOARD LAYOUT

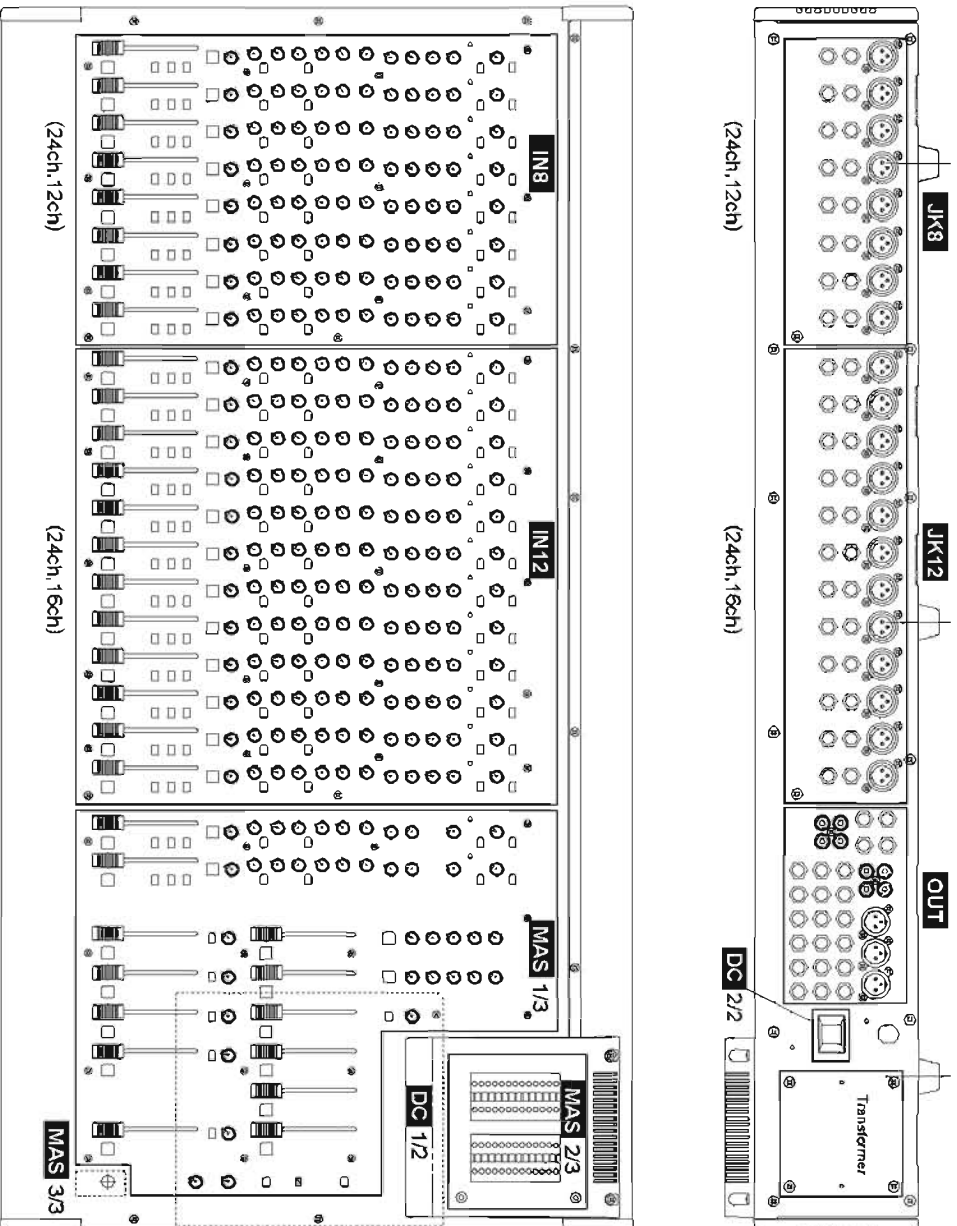

■ WIRING

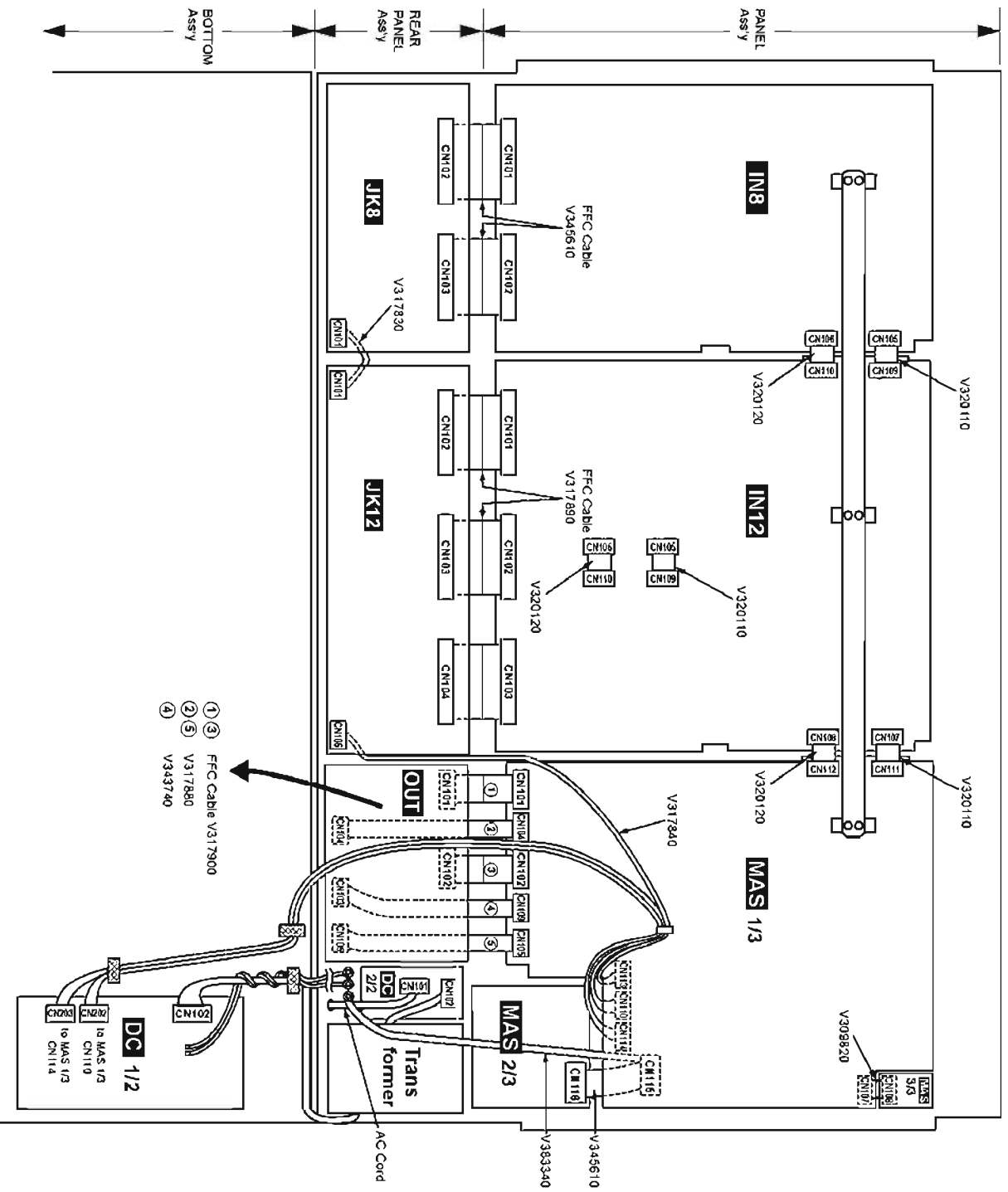

JNC2-V329380

DISASSEMBLY PROCEDURE

[GF 12/12]

1. **Panel Assembly**
 - 1-1 Remove the two (2) screws marked [170a] and the two (2) screws marked [170b] from the corner pad. The corner pad can then be removed (Fig. 1, 2, 3).
 - 1-2 Remove the screws marked [100a] and [100b] on the rear panel assembly.

The quantity of the screws marked [100a] and [100b] are:

 - [100a] : four (4) on the GF-12-12 (Fig. 1)
 - : five (5) on the GF16-12 (Fig. 2)
 - : six (6) on the GF24-12 (Fig. 3)
 - [100b] : one (1) on the GF12-12 (Fig. 1)
 - : one (1) on the GF16-12 (Fig. 2)
 - : two (2) on the GF24-12 (Fig. 3)
 - 1-3 Remove the screws marked [90] on the panel surface of the panel assembly.

The quantity of the screws marked [90] are:

 - [90] : eight (8) on the GF12-12 (Fig. 1)
 - : eight (8) on the GF16-12 (Fig. 2)
 - : ten (10) on the GF24-12 (Fig. 3)
 - 1-4 Remove the six (6) screws marked [120a] on each side of the panel assembly
 - 1-5 Remove the screws marked [290] on the bottom face of the panel assembly on the fader side.

The quantity of the screws marked [290] are:

 - [290] : four (4) on the GF12-12 (Fig. 1)
 - : five (5) on the GF16-12 (Fig. 2)
 - : six (6) on the GF24-12 (Fig. 3)
 - 1-6 Remove the one (1) screw marked [120b] and the screw marked [130] where the corner pad was removed
 - * Loosening the screw marked [130] allows the panel assembly to open about 45 degrees. When working with the panel opened, secure the panel assembly by installing the fixed stay before beginning work.
 - 1-7 While tilting the fader side of the panel assembly, remove the panel assembly from the pivots located on the rear panel side of the bottom assembly
2. **Rear Panel Assembly**
 - 2-1 Remove the panel assembly. (See Procedure 1.)
 - 2-2 Remove the two (2) screws marked [100c] on each side of the section where the corner pad was removed (Fig. 1, 2, 3).
 - 2-3 Remove the screws marked [100d] on the rear panel.

The quantity of the screws marked [100d] are:

 - [100d] : four (4) on the GF-12-12 (Fig. 1)
 - : five (5) on the GF16-12 (Fig. 2)
 - : six (6) on the GF24-12 (Fig. 3)
 - 2-4 Remove the two (2) screws marked [280]. The rear assembly can then be removed.
 - 2-5 Remove the screws marked [110] on the panel surface. The rear panel assembly can then be removed.

The quantity of the screws marked [110] are:

 - [110] : four (4) on the GF-12-12 (Fig. 1)
 - : five (5) on the GF16-12 (Fig. 2)
 - : six (6) on the GF24-12 (Fig. 3)

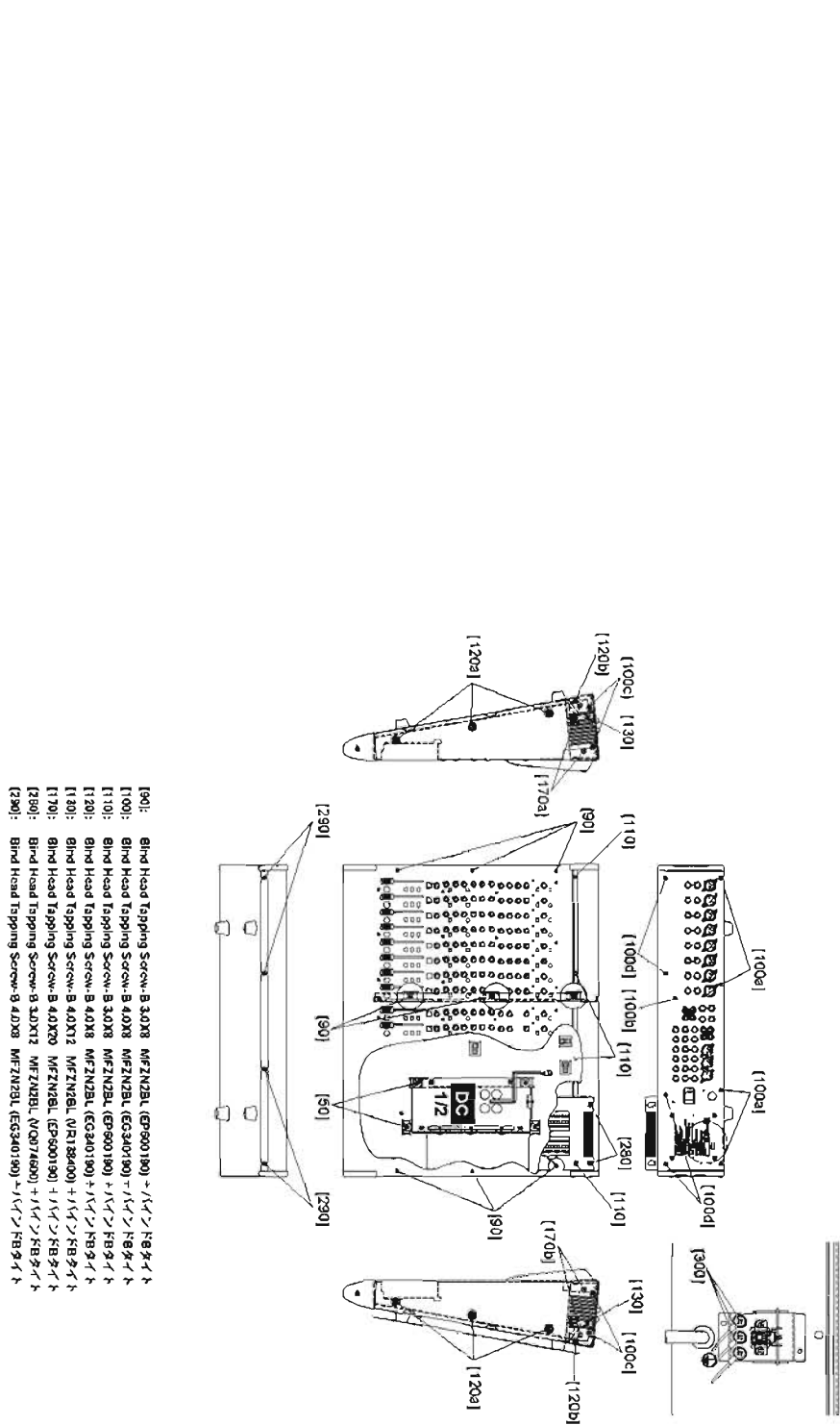

[GF 16/12]

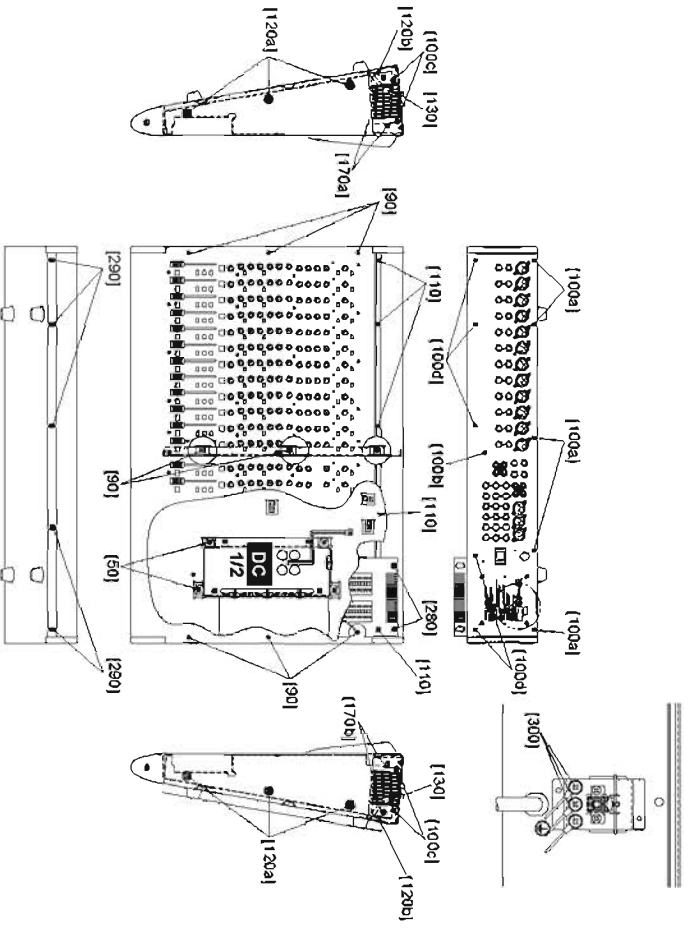

- [90]: Blind Head Tapping Screw-B 3.0X8 MFZN2BL (EP960190)
- [100]: Blind Head Tapping Screw-B 4.0X8 MFZN2BL (EG340190)
- [110]: Blind Head Tapping Screw-B 3.0X8 MFZN2BL (EP960190)
- [120]: Blind Head Tapping Screw-B 4.0X8 MFZN2BL (EG340190)
- [130]: Blind Head Tapping Screw-B 4.0X12 MFZN2BL (OR138400)
- [170]: Blind Head Tapping Screw-B 4.0X20 MFZN2BL (EP960190)
- [280]: Blind Head Tapping Screw-B 3.0X12 MFZN2BL (V0074600)
- [290]: Blind Head Tapping Screw-B 4.0X8 MFZN2BL (EG340190)

Fig. 2

[GF 24/12]

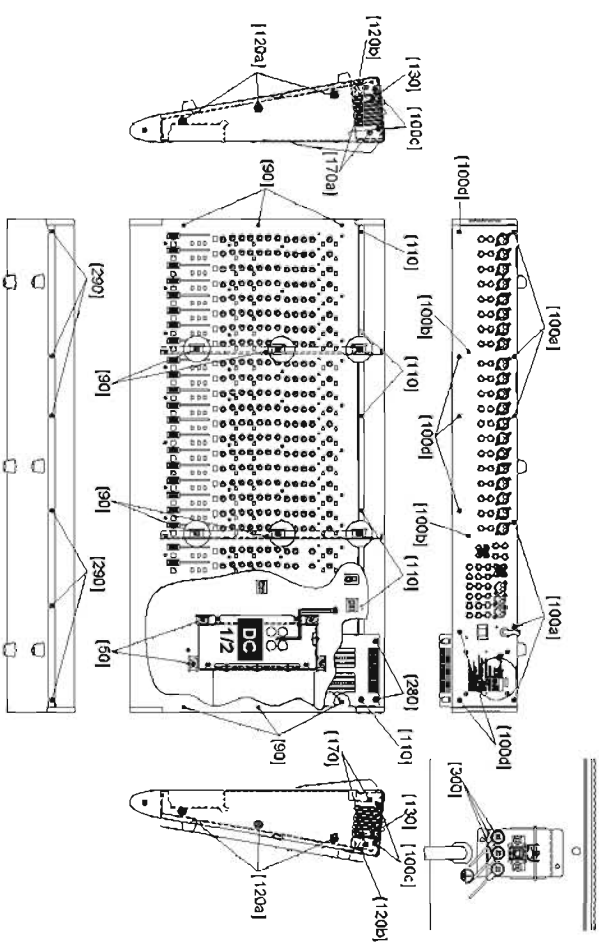

- [90]: Blind Head Tapping Screw-B 3.0X8 MFZN2BL (EP960190)
- [100]: Blind Head Tapping Screw-B 4.0X8 MFZN2BL (EG340190)
- [110]: Blind Head Tapping Screw-B 3.0X8 MFZN2BL (EP960190)
- [120]: Blind Head Tapping Screw-B 4.0X8 MFZN2BL (EG340190)
- [130]: Blind Head Tapping Screw-B 4.0X12 MFZN2BL (OR138400)
- [170]: Blind Head Tapping Screw-B 4.0X20 MFZN2BL (EP960190)
- [280]: Blind Head Tapping Screw-B 3.0X12 MFZN2BL (V0074600)
- [290]: Blind Head Tapping Screw-B 4.0X8 MFZN2BL (EG340190)

Fig. 3

3. **MAS 1/3 Circuit Board**
 - 3-1 Remove the panel assembly. (See Procedure 1.)
 - 3-2 Remove the rear panel assembly. (See Procedure 2.)
 - 3-3 Remove the screws marked [65] on the ground bar. The quantity of the screws marked [65] are:
 - [65] : four (4) on the GF 12-12 (Fig. 4)
 - : four (4) on the GF 16-12 (Fig. 5)
 - : six (6) on the GF 24-12 (Fig. 6)
 - 3-4 Remove the thirteen (13) fader knobs and the forty (40) knobs on the panel surface (Fig. 4, 5, 6)
 - 3-5 Remove the sixteen (16) button screws that have a hexagonal hole marked [50a] on the panel surface. The MAS 1/3 circuit board can then be removed. (Fig. 4, Fig. 5, Fig. 6)
4. **IN12 Circuit Board (applicable to GF24/12 and GF16/12)**
 - 4-1 Remove the rear panel assembly. (See Procedure 1.)
 - 4-2 Remove the rear panel assembly. (See Procedure 2.)
 - 4-3 Remove the ground bar. (See Step 3-3.)
 - 4-4 Remove the twelve (12) fader knobs and the one-hundred and forty-four (144) knobs on the panel surface (Fig. 5, Fig. 6)
 - 4-5 Remove the twenty (20) button screws that have a hexagonal hole marked [50b] on the panel surface. The IN 12 circuit board can then be removed. (Fig. 5, Fig. 6)
5. **IN8 Circuit Board (applicable to GF24/12 and GF12/12)**
 - 5-1 Remove the panel assembly. (See Procedure 1.)
 - 5-2 Remove the rear panel assembly. (See Procedure 2.)
 - 5-3 Remove the ground bar. (See Step 3-3.)
 - 5-4 Remove the eight (8) fader knobs and the ninety-six (96) knobs on the panel surface
 - 5-5 Remove the twelve (12) button screws that have a hexagonal hole marked [50c] on the panel surface. The IN8 circuit board can then be removed. (Fig. 4, Fig. 6)

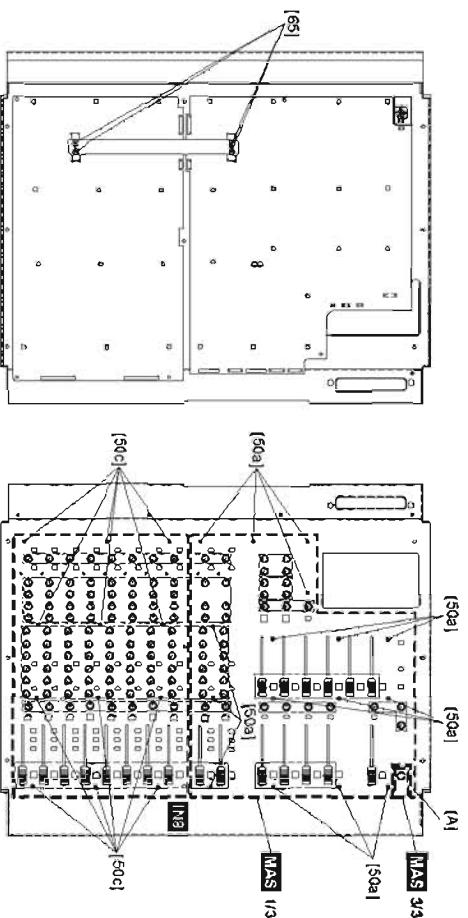

[50a] Screw 3X25 M/FZN2BL (N2389400)
[65] Blind Head Screw 4.0X8 M/FZN2BL (EG340360)

Fig. 4

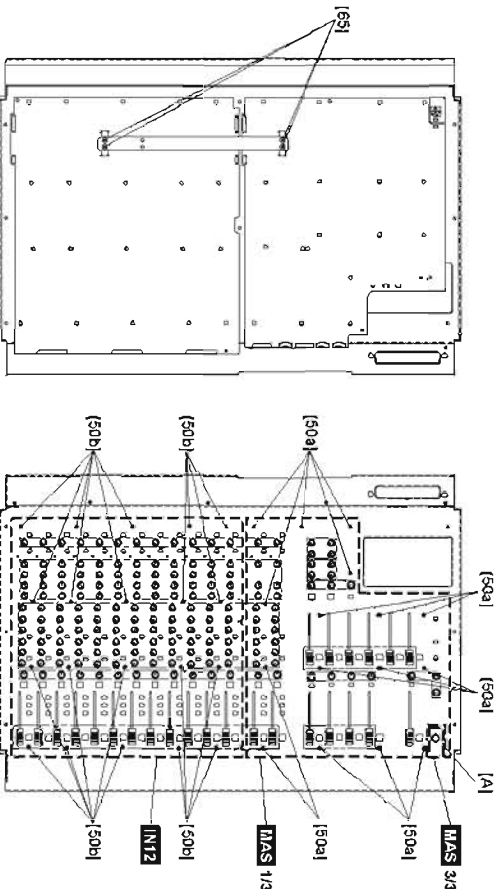

[50a] Screw 3X25 M/FZN2BL (N2389400)
[65] Blind Head Screw 4.0X8 M/FZN2BL (EG340360)

Fig. 5

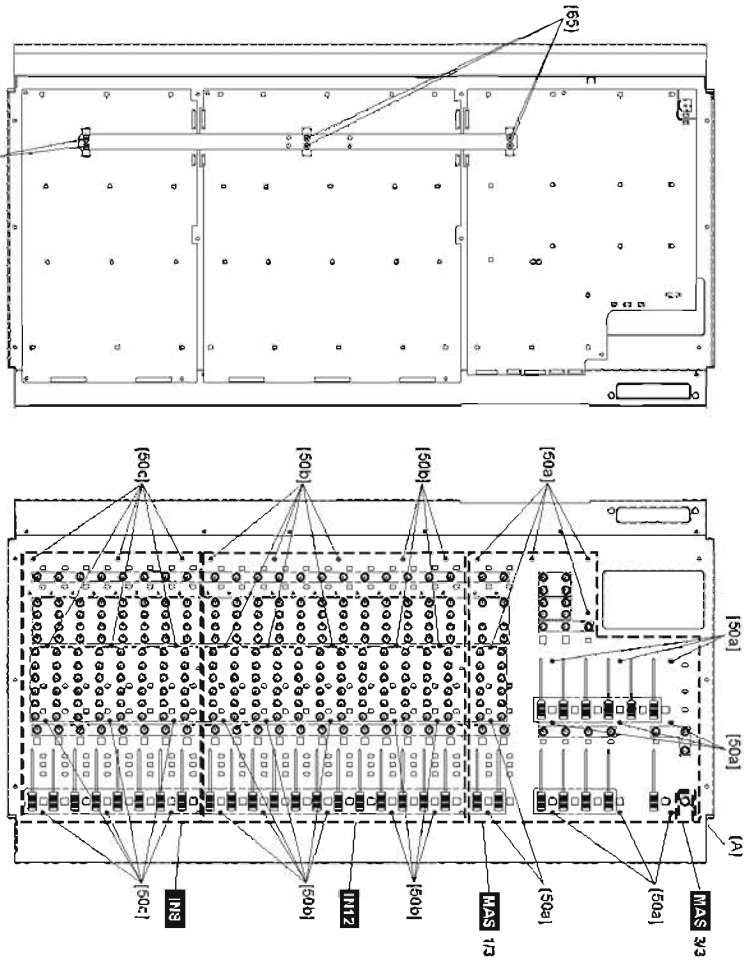

Fig 6

- 6. **MAS 2/3 Circuit Board**
- 6-1 Remove the meter assembly. (See Step 2.4.)
- 6-2 Remove the four (4) screws marked [20]. The MAS 2/3 circuit board can then be removed (Fig. 7)
- 7. **MAS 3/3 Circuit Board**
- 7-1 Remove the panel assembly. (See Procedure 1)
- 7-2 Remove the hexagonal nut marked [A] at the right end of the panel surface. The MAS 3/3 circuit board can then be removed. (Fig. 4, Fig. 5, Fig. 6)

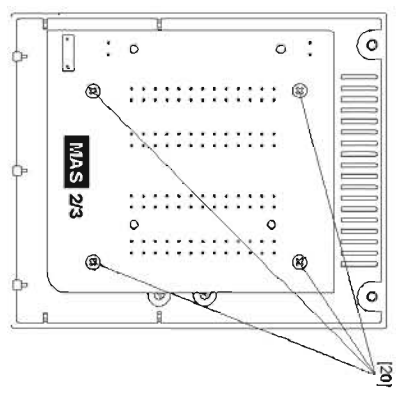

Fig. 7

- 8. **DC 1/2 Circuit Board**
- 8-1 Remove the panel assembly. (See Procedure 1.)
- 8-2 Remove the four (4) screws marked [50] and the three (3) screws marked [300] securing the CN2 wire of the PSW. The power assembly can then be removed. (Fig. 1, Fig 2, Fig. 3)
- 8-3 Remove the three (3) screws marked [70], the screw marked [50], and the four (4) screws marked [40]. The DC 1/2 circuit board can then be removed. (Fig. 8)

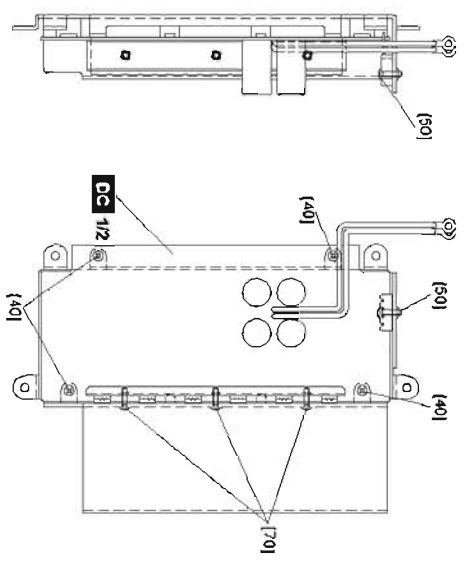
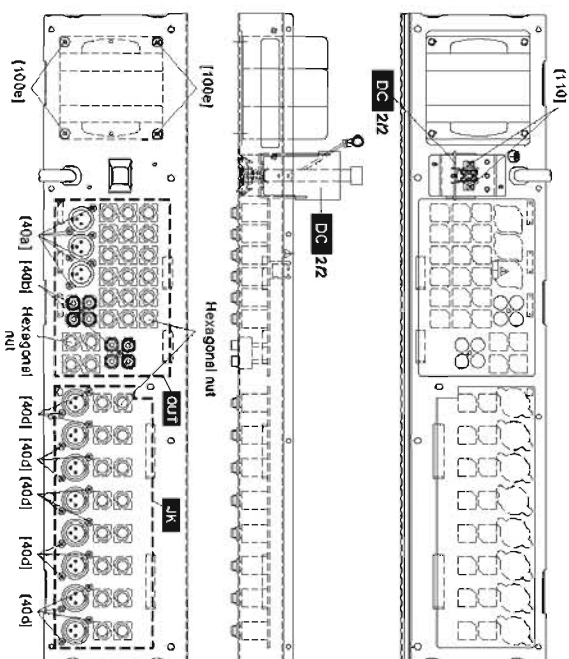

Fig 8

- (40): Power Supply Assembly GF24 J U (EG340130)
- (50): Blind Head Tapping Screw-B 4.0X8 M7ZN2BL (EG340130)
- (70): Rear Panel Assembly GF 24 (VZ735110)

9. **DC 2/2 Circuit Board**
 - 9-1 Remove the panel assembly. (See Procedure 1.)
 - 9-2 Remove the rear panel assembly. (See Procedure 2.)
 - 9-3 Remove the two (2) screws marked (110) on the rear panel. The DC 2/2 circuit board can then be pulled out. (Fig. 9, Fig. 10, Fig. 11)
10. **OUT Circuit Board**
 - 10-1 Remove the panel assembly. (See Procedure 1.)
 - 10-2 Remove the rear panel assembly. (See Procedure 2.)
 - 10-3 Remove the six (6) screws marked (40b) on the rear panel side of the DIN connectors, the two (2) screws marked (40b), and the twenty-two (22) hexagonal nuts fixing the jack. The OUT circuit board can then be removed. (Fig. 9, Fig. 10, Fig. 11)
11. **JK12 Circuit Board (applicable to GF24/12 and GF16/12)**
 - 11-1 Remove the panel assembly. (See Procedure 1.)
 - 11-2 Remove the rear panel assembly. (See Procedure 2.)
 - 11-3 Remove the twenty-four (24) screws marked (40c) of the DIN connectors on the rear panel side, and the twenty-four (24) hexagonal nuts fixing the jack. The JK12 circuit board can then be removed. (Fig. 10, Fig. 11)
12. **JK8 Circuit Board (applicable to GF24/12 and GF12/12)**
 - 12-1 Remove the panel assembly. (See Procedure 1.)
 - 12-2 Remove the rear panel assembly. (See Procedure 2.)
 - 12-3 Remove the sixteen (16) screws marked (40d), of the DIN connectors on the rear panel side, and the sixteen (16) hexagonal nuts fixing the jack. The JK8 circuit board can then be removed. (Fig. 9, Fig. 11)
13. **Power Transformer**
 - 13-1 Remove the panel assembly. (See Procedure 1.)
 - 13-2 Remove the rear panel assembly. (See Procedure 2.)
 - 13-3 Remove the four (4) screws marked (100d) on the rear panel surface. The power transformer can then be removed. (Fig. 9, Fig. 10, Fig. 11)



(40a) Bonding Tapping Screw-B 3.0X8 MFZN2BL (VN413300)
(100) Blind Head Tapping Screw-B 4.0X12 MFZN2BL (NR134400)
(110) Blind Head Tapping Screw-B 3.0X8 MFZN2BL (EP600190)

Fig. 9

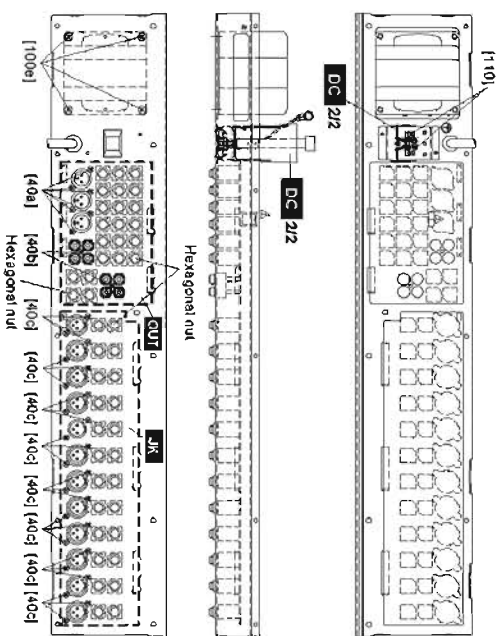

(40c) Bonding Tapping Screw-B 3.0X8 MFZN2BL (VN413300)
(100) Blind Head Tapping Screw-B 4.0X12 MFZN2BL (NR134400)
(110) Blind Head Tapping Screw-B 3.0X8 MFZN2BL (EP600190)

Fig. 10

CIRCUIT BOARDS

• MAS 2/3 Circuit Board

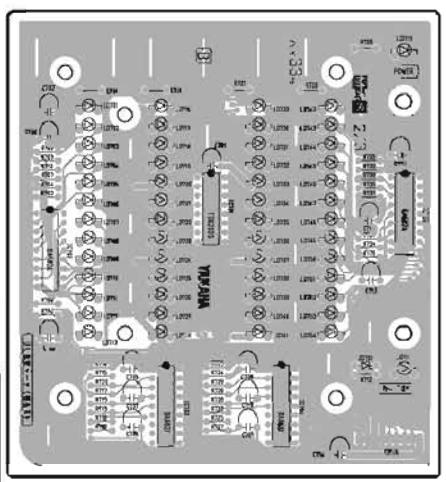

Component side

• MAS 1/3 Circuit Board

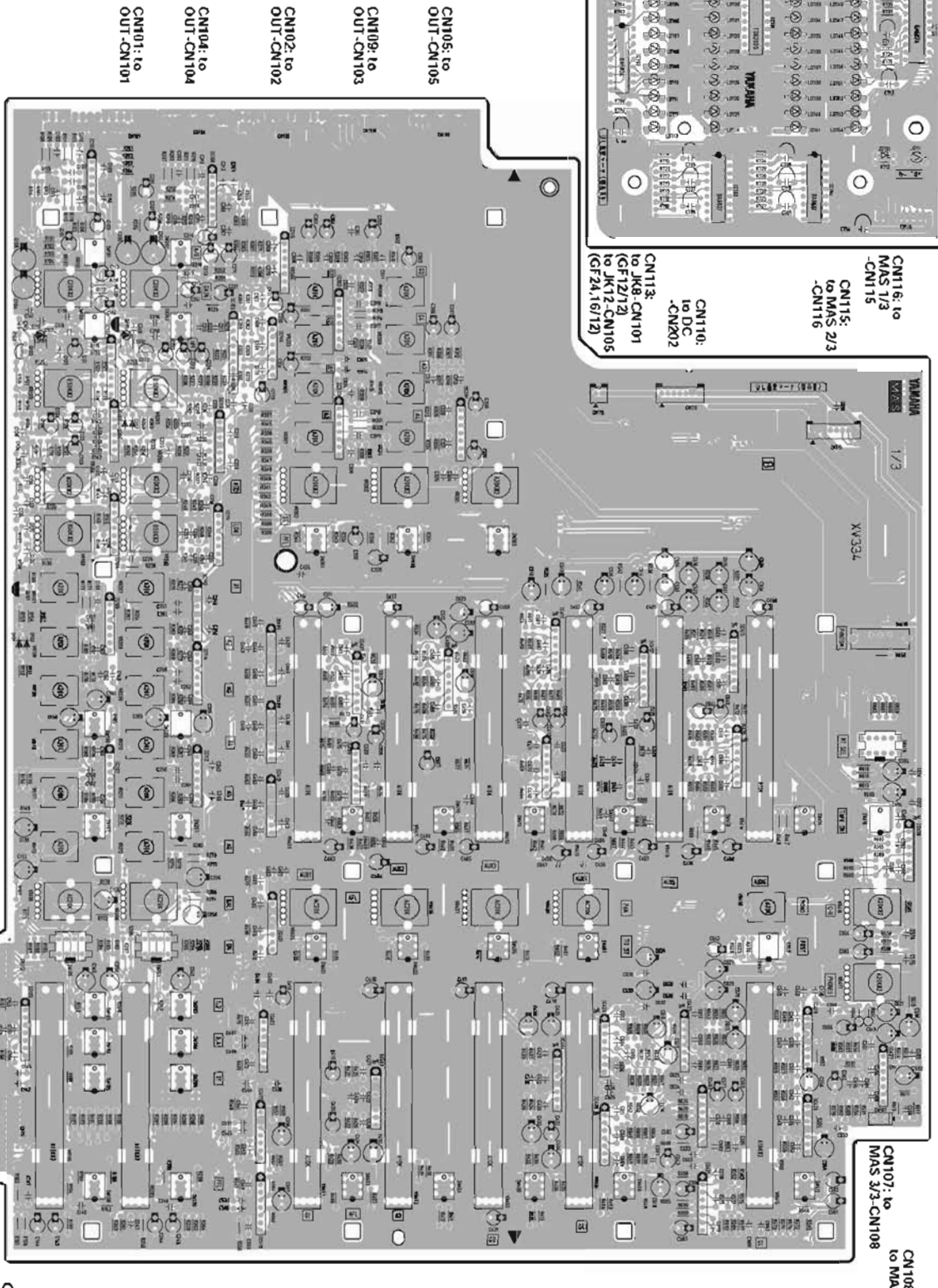

Component side

• MAS 2/3 Circuit Board



Component side

- CN105: to
OUT-CN105
- CN109: to
OUT-CN103
- CN102: to
OUT-CN102
- CN104: to
OUT-CN104
- CN101: to
OUT-CN101

- CN116: to
MAS 1/3
-CN115
- CN115: to
MAS 2/3
-CN116
- CN110:
to DC
-CN202
- CN113:
to JK8-CN101
(GF12/12)
to JK12-CN105
(GF24,16/12)

- CN107: to
MAS 2/3-CN108
- CN108:
to MAS 1/3-CN107

- CN112: to IN8-CN106(GF12/12)
- CN112: to IN12-CN109(GF24,16/12)
- CN111: to IN8-CN105(GF12/12)
- CN111: to IN12-CN107(GF24,16/12)

Note: See parts list for details of circuit board component parts.

MAS: 3NA-V289420

• MAS 2/3 Circuit Board



Pattern side

• MAS 1/3 Circuit Board

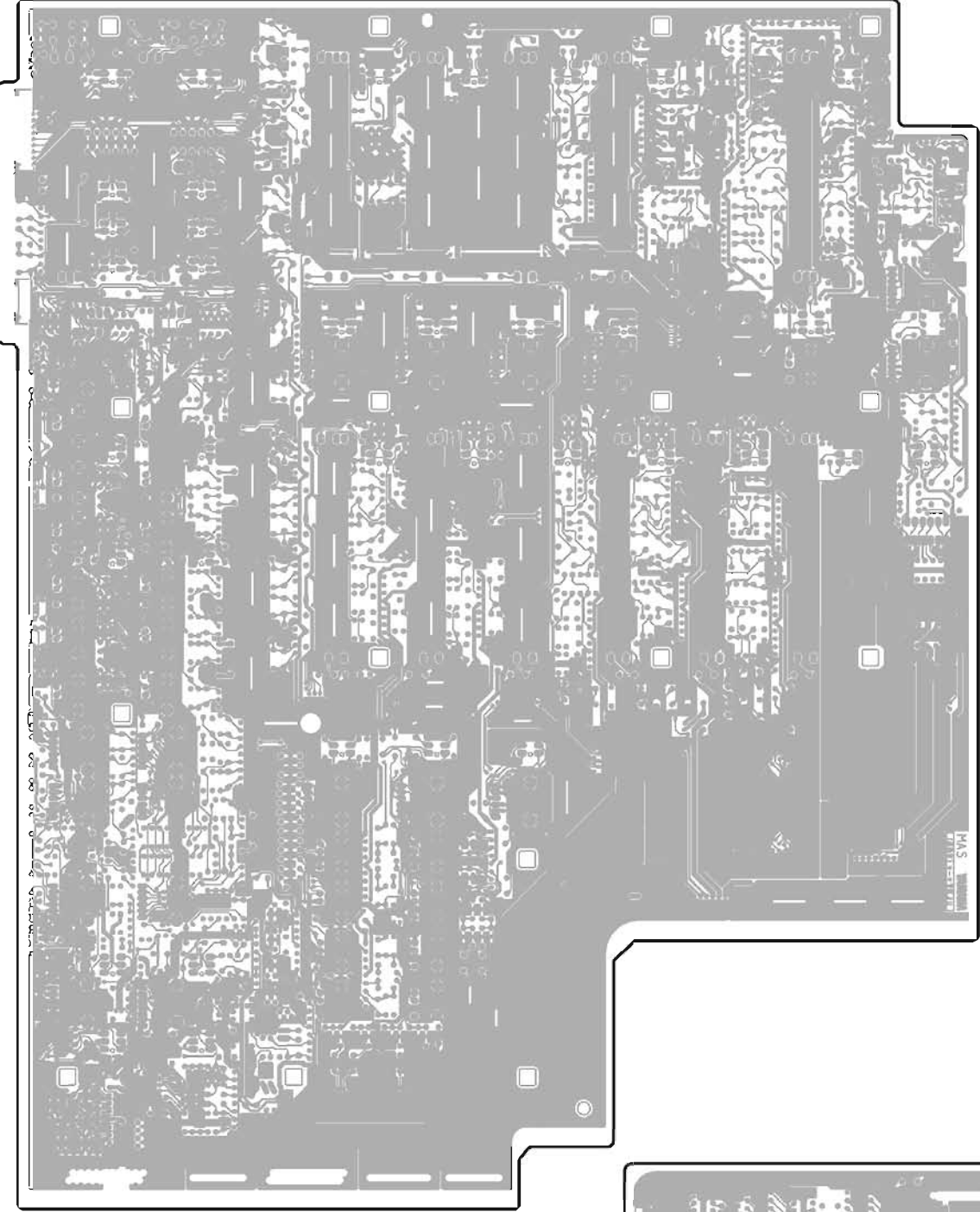

Pattern side

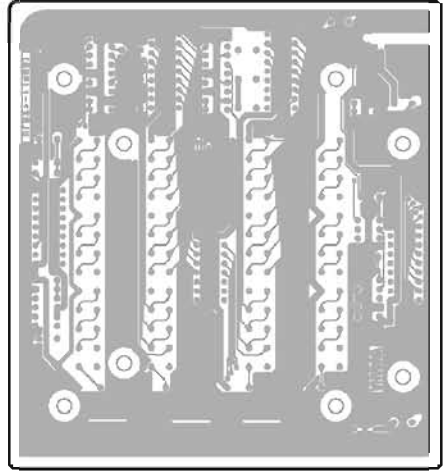

Pattern side

• IN8 Circuit Board

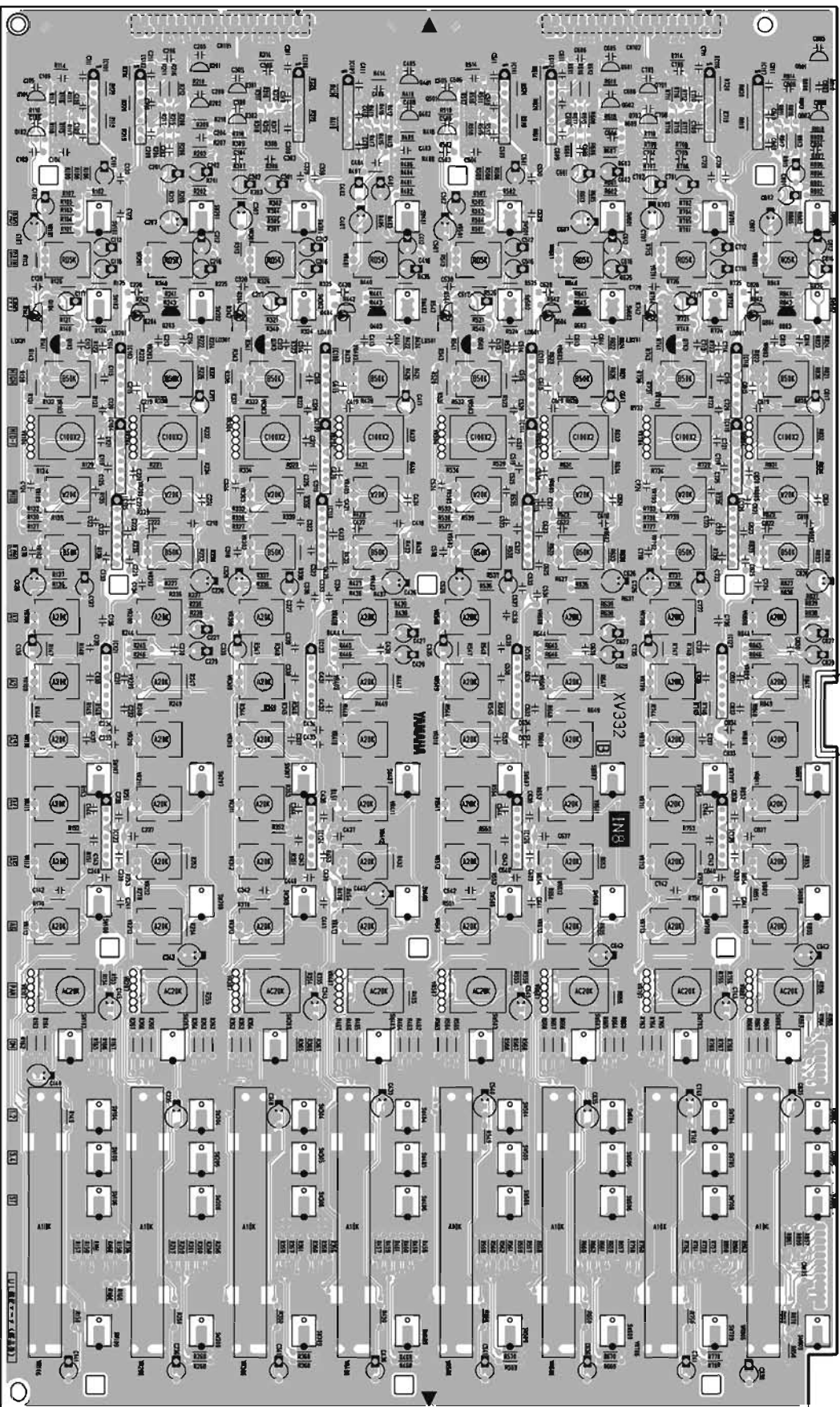

Component side

IN8: 3NA-V288400 ▲

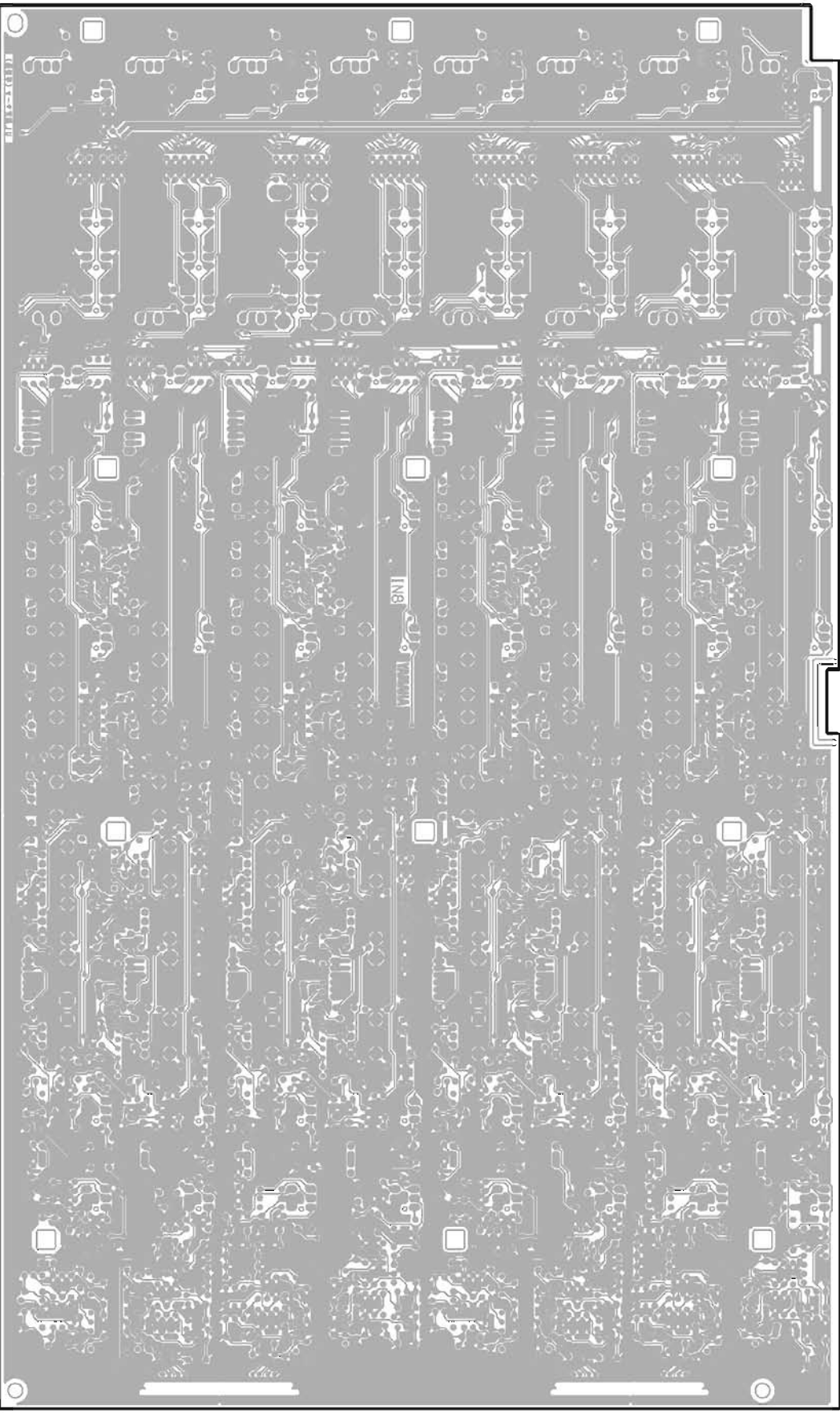

Pattern side

■ IN12 Circuit Board

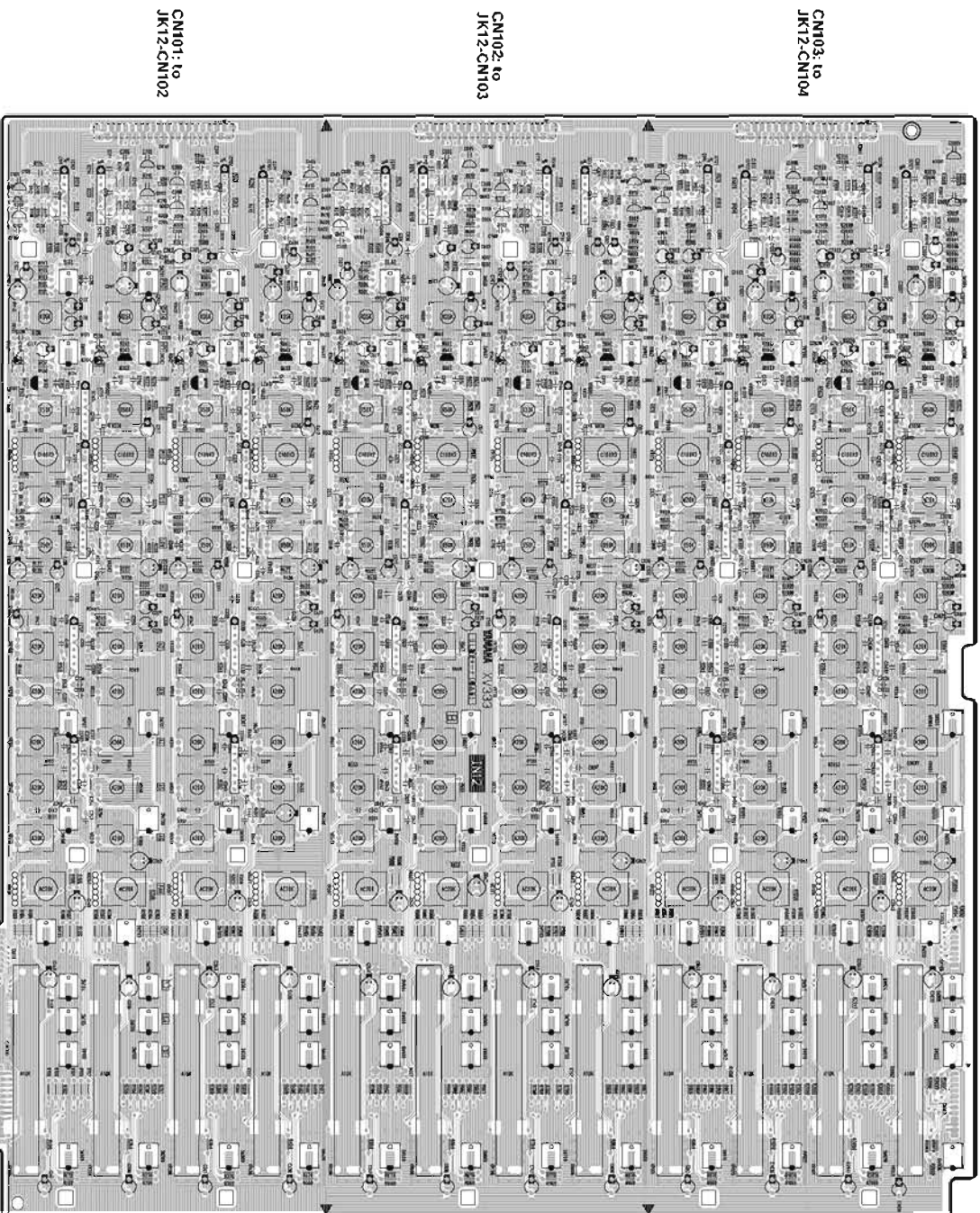

CN108: to
MAS 1/3-CN112

CN107: to
MAS 1/3-CN111

CN103: to
JK12-CN104

CN102: to
JK12-CN103

CN101: to
JK12-CN102

CN110: to IN8-CN106
(GF24/12only)

CN109: to IN8-CN105
(GF24/12only)

Component side

IN12: 3NA-V289A10 ▽

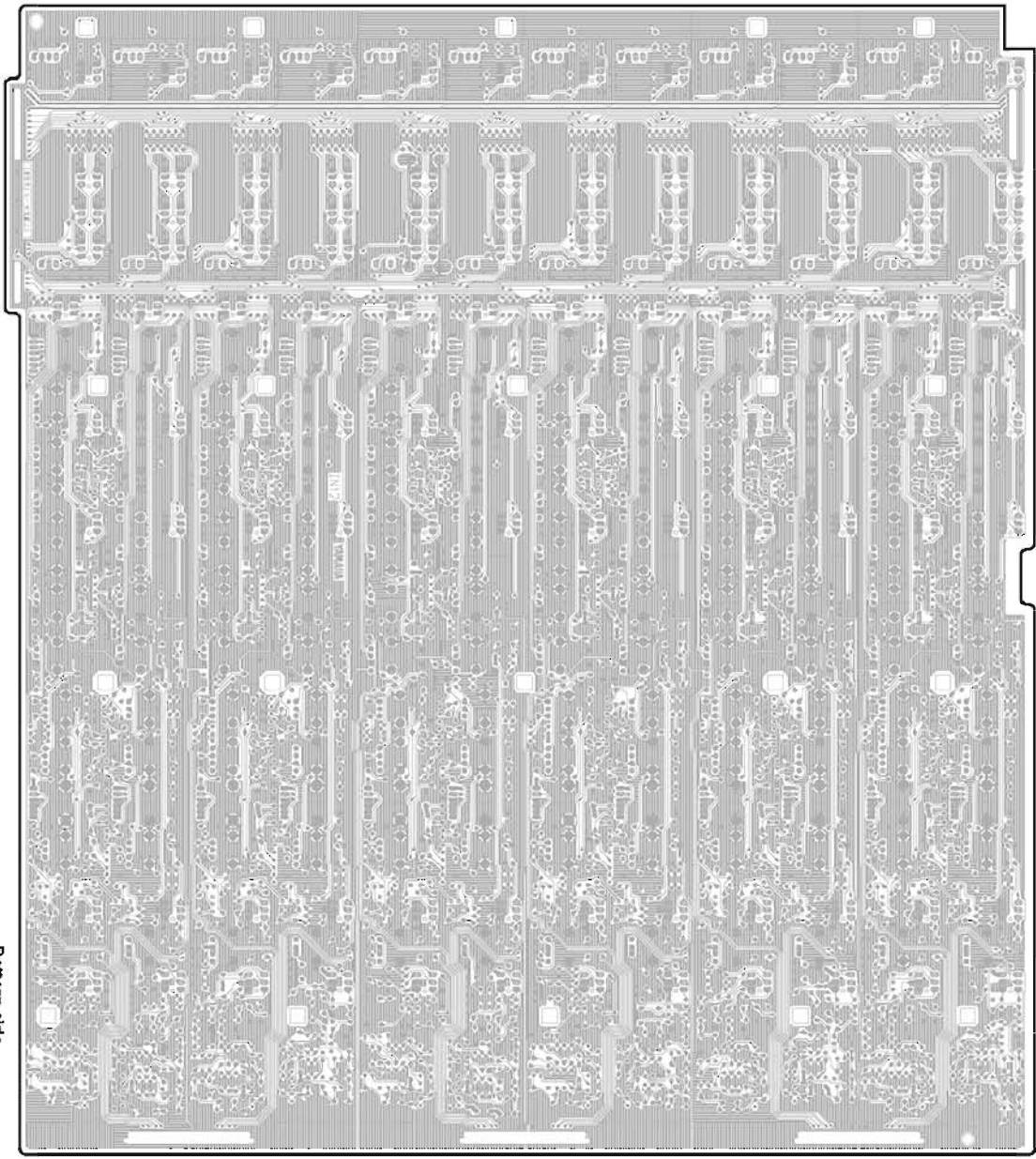

Pattern side

• DC 1/2 Circuit Board

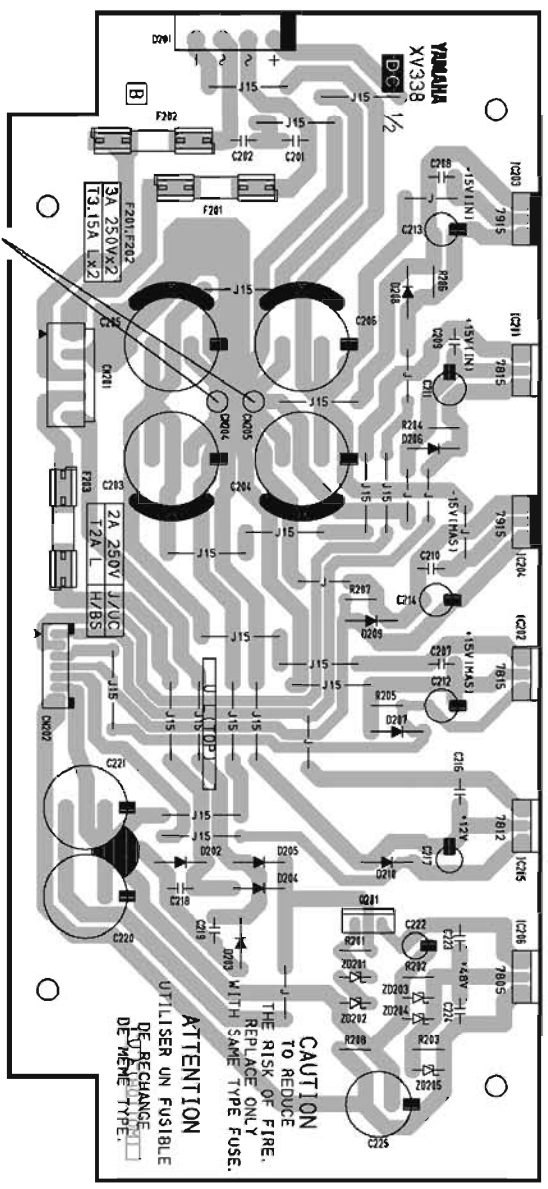

Rear Panel
 GND CN201: to Transformer
 CN202: to MAS 1/3-CN110
 CN203: to MAS 1/3-CN114

• DC 2/2 Circuit Board

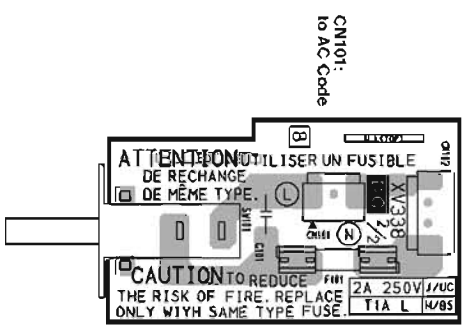

Component side

• OUT Circuit Board

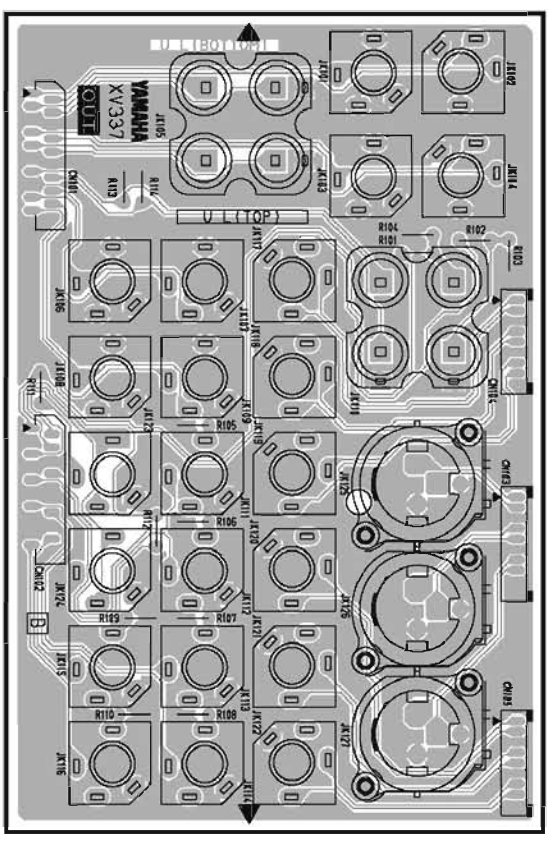

Rear Panel
 CN101: to MAS 1/3-CN101
 CN102: to MAS 1/3-CN102

Component side

• JK9 Circuit Board

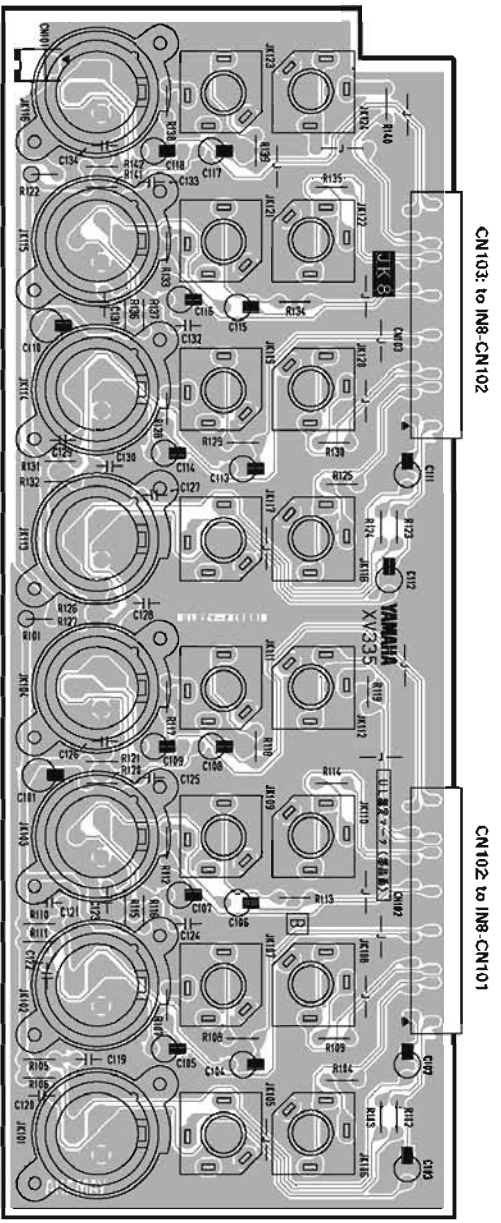

CN103: to IN8-CN102

CN102: to IN8-CN101

CN101: to MAS 1/3-CN113

Component side

• JK12 Circuit Board

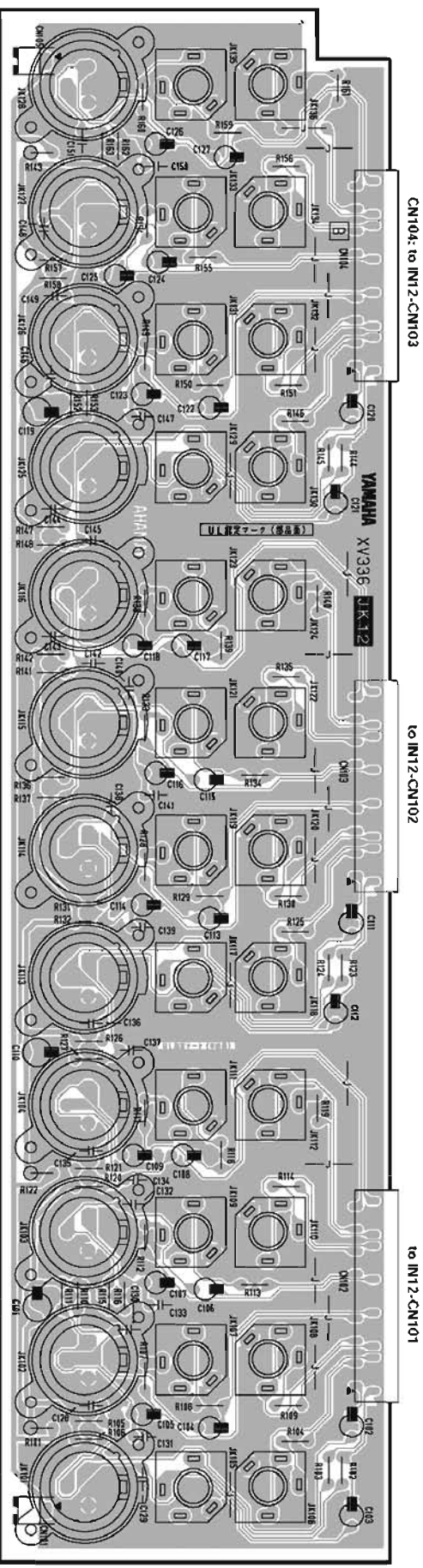

CN104: to IN2-CN103

to IN2-CN102

to IN2-CN101

CN105: to MAS 1/3-CN113

CN101: to IN2-CN10 (GF24/12 only)

Component side

JK9: 3NA-V288430
JK12: 3NA-V288440

INSPECTIONS

1. PREPARATION

1-1 Unless specified, the signal applied should be a 1 kHz sine wave and the impedance of the signal source should be 150 ohms.

CH INSERT OUT, ST INSERT OUT, REC OUT 10 Kohm
 GROUP OUT, AUX OUT, ST OUT, MONO OUT, C-R OUT 600 ohm
 PHONES 40 ohm

1-2 Unless specified, set the knobs as follows.

CH INPUT (1-8, 12, 20)
 PAD switch OFF
 GAIN trim Maximum
 HPF switch OFF
 EQ (HIGH, MID, LOW) gain control Center
 EQ (MID) FREQ control Minimum
 AUX 1 to 6 LEVEL control Maximum
 AUX 3/4, 5/6 PRE switch ON during measurement only, OFF at all other times
 PAN control Center
 ON switch ON during measurement only, OFF at all other times
 Fader Maximum
 PFL switch OFF
 Stereo input (9-16, 21-24)
 A/B switch OFF (A)
 GAIN trim Maximum
 HPF switch OFF
 EQ (HIGH, MID, LOW) gain control Center
 AUX 1 to 6 LEVEL control Maximum
 AUX 3/4, 5/6 PRE switch ON during measurement only, OFF at all other times
 BAL. control Center
 ON switch ON during measurement only, OFF at all other times
 Fader Maximum
 PFL switch OFF
 MASTER
 GROUP (1-4)
 PAN control Center
 TO ST switch ON during measurement only, OFF at all other times
 Fader Maximum
 AFL switch ON during measurement only, OFF at all other times
 AUX (1-6)
 Fader Maximum
 AFL switch ON during measurement only, OFF at all other times

ST

Fader Maximum
 AFL switch ON during measurement only, OFF at all other times
 MONO
 LEVEL control Maximum
 POST switch ON during measurement only, OFF at all other times
 C-R MONITOR
 TAPE IN switch OFF
 LEVEL control Maximum
 PHONES
 LEVEL control Maximum during measuring only, minimum at all other times
 AUX RETURN 1
 GROUP 1, 2 level control Maximum during measuring only, minimum at all other times
 AUX 1, 2 level control Maximum during measuring only, minimum at all other times
 ST level control Maximum during measuring only, minimum at all other times
 PFL switch ON during measurement only, OFF at all other times
 AUX RETURN 2
 GROUP 3, 4 level control Maximum during measuring only, minimum at all other times
 AUX 3, 4 level control Maximum during measuring only, minimum at all other times
 ST levels control Maximum during measuring only, minimum at all other times
 PFL switch ON during measurement only, OFF at all other times
 TAPE IN
 ST level control Maximum
 ON switch ON during measurement only, OFF at all other times
 METERS SELECT
 GROUP 1, 2/ST L, R, PRE, AFL TAPE IN L, R select switch
 ON during measurement only, OFF at all other times
 PHANTOM
 PHANTOM switch OFF

2-1 Gain

In status 1-1, the output levels should be within the range given in Tables 1 and 11.

(For the items marked with an asterisk (*) in the table below, refer to 2-2 Frequency Response.)

(For the items marked with two asterisks (**) in the table below, refer to 2-8 Distortion.)

Table 1: Input Terminal [INPUT CH TO 6, 12, 20]

(Do not put any input into B.)

[Unit: dBs]

Input Level	GAIN	PAD	AUX PRE	PAN	GROUP (1 to 4) OUT	AUX (1, 2) OUT	AUX (3 to 6) OUT	ST (L, R) OUT	C-R (L, R) OUT *1
-70	MAX	OFF	OFF	L	*, ** +14 +/- 2 (GROUP 1, 3)	*, ** +10 +/- 2	*, ** +20 +/- 2	*, ** +14 +/- 2 (ST L)	*, ** 0 +/- 2
				R	*, ** +14 +/- 2 (GROUP 2, 4)	-	-	*, ** +14 +/- 2 (ST R)	-
				ON	L	-	-	+10 +/- 2	-
-26	MIN	OFF	OFF	L	* +14 +/- 2 *2	-	-	-	
0	MIN	ON	OFF	L	+14 +/- 2 *2	-	-	-	

*1: When a signal is applied to the C-R MONITOR OUT, you should turn the PFL switch "ON".

*2: Measure only GROUP1.

- 1) The difference in the levels of the CH INPUTs (1– 8; 12; 20) of each output should be less than 2 dB.
- 2) The difference in the levels of the GROUP (1 - 4) OUT; AUX (1, 2) OUT; AUX (3 - 6) OUT and ST (L, R) OUT should be less than 2 dB.

Table 2: INPUT B (CH INPUT 1– 8; 12; 20)

(Do not put any input into A.)

[Unit: dBs]

Input	Input Level	GAIN	PAD	CH INSERT OUT	GROUP 1 OUT
CH INPUT	-70	MAX	OFF	-10 +/- 2	+14 +/- 2
CH INSERT IN	-10	MAX	OFF	-	+14 +/- 2

- 1) The difference in the levels of the CH INPUT (1–8; 12; 20) of each output should be less than 2 dB.
- 2) The PAN VR should be turned fully counterclockwise.

Table 3: ST INPUT A L (CH9; 11-13; 15-21; 23)

(Do not put any input into CH 10; 12-14; 16-22; 24.)

[Unit: dBs]

Input Level	GAIN	AUX PRE	PAN	GROUP (1 to 4) OUT	AUX (1, 2) OUT	AUX (3 to 6) OUT	ST (L, R) OUT	C-R (L, R) OUT *1
-44	MAX	OFF	L	*(GROUP 1 only) ** +14 +/- 2 (GROUP 1, 3)	** +13 +/- 2	** +23 +/- 2	** +14 +/- 2 (ST L)	** 0 +/- 2
			R	*(GROUP 2 only) ** +14 +/- 2 (GROUP 2, 4)	-	-	** +14 +/- 2 (ST R)	-
		ON	L	-	-	+13 +/- 2	-	-
0	MIN	OFF	L	* +14 +/- 2 (GROUP 1)	-	-	-	-
			R	+14 +/- 2 (GROUP 2)				

*1: Turn on the PFL switch when you measure the C-R OUT.

- 1) The difference in the levels of the ST INPUT (9; 11-13; 15-21; 23) of each output should be less than 2 dB.
- 2) The difference in the levels of the GROUP (1-4) OUT; AUX (1, 2) OUT; AUX (3-6) OUT and ST (L, R) OUT should be less than 2 dB.

Table 4: Input Terminal ST INPUT A R (CH10; 12-14; 16-22; 24)

(Do not put any input into CH9; 11-13; 15-21; 23.)

[Unit: dBs]

Input Level	GAIN	PFL SW	C-R (L) OUT	C-R (R) OUT
-44	MAX	ON	No output	0 +/- 2

- 1) The difference in the levels of the ST INPUT (10; 12-14; 16-22; 24) of each output should be less than 2 dB.

Table 5: Input Terminal ST INPUT B (CH 9-16; 21-24)

[Unit: dBs]

Input Terminal	Input Level	GAIN	PFL SW	C-R L OUT	C-R R OUT
9; 11-13; 15-21; 23	-44	MAX	ON	0 +/- 2	-
10; 12-14; 16-22; 24				-	0 +/- 2

- 1) Turn the ST INPUT A/B switch on at "ON (B)."
- 2) The difference in the levels of the ST INPUT (9-16; 22-24) of each output should be less than 2 dB.

Table 6: Input Terminal CH1 INPUT [Unit: dBs]

Input Level	GAIN	POST	MONO OUT	REC OUT (L,R)
-70	MAX	OFF	* , ** +10 +/- 2	** -7.8 +/- 2
		ON	+20 +/- 2	-

- 1) Turn on the ST assign switch of CH1 INPUT.
- 2) When the signal is applied to the MONO OUT, set the CH PAN to the center.
- 3) When the signal is applied to the REC OUT, turn the CH PAN to L (for maximum turn counterclockwise) or R (for maximum turn clockwise).

Table 7: Input Terminal CH1 INPUT [Unit: dBs]

Input Level	GAIN	CH1 PAN VR	Select Switch GROUP TO ST switch	GROUP TO ST PAN	ST L OUT	ST R OUT
-80	MAX	L	GROUP 1, 3	L	+14 +/- 2	-
				R	-	+14 +/- 2
		R	GROUP 2, 4	L	+14 +/- 2	-
				R	-	+14 +/- 2

- 1) Turn on the GROUP (1-2; 3-4) assign switch of CH1.
- 2) Turn off the ST assign switch.
- 3) Turn on one of the TO ST switches in GROUP (1 - 4).

Table 8: Input terminal CH1 INPUT, OUTPUT C - R MONITOR L R OUT [Unit: dBs]

Input Level	GAIN	PAD	AUX PRE	PAN	GROUP (1, 3) AFL ON	GROUP (2, 4) AFL ON	AUX (1, 2) AFL ON	AUX (3 to 6) AFL ON	ST (L, R) AFL ON
-80	MAX	OFF	OFF	L	+10 +/- 2	-	+6 +/- 2	+16 +/- 2	* +10 +/- 2 (C-R L)
				R	-	+10 +/- 2	-	-	* +10 +/- 2 (C-R R)

Table 9: Input terminal AUX RETURN

[Unit: dBs]

Input	Input Level	GROUP (1, 2) OUT	GROUP (3, 4) OUT	AUX (1, 2) OUT	AUX (3, 4) OUT	ST(L, R) OUT	C-R (L, R) OUT *1
1L (No plug for 1R)	-6	*A ** +10 +/- 2	-	** +10 +/- 2	-	** +10 +/- 2	** 0 +/- 2
2L (No plug for 2R)		-	*, ** +10 +/- 2	-	** +10 +/- 2	** +10 +/- 2	** 0 +/- 2
1R		GROUP 1 No output GROUP 2 +10 +/- 2	-	AUX 1 No output AUX 2 +10 +/- 2	-	ST L No output ST R +10 +/- 2	C-R L No output C-R R 0 +/- 2
2R		-	GROUP 3 No output GROUP 4 +10 +/- 2	-	AUX 3 No output AUX 4 +10 +/- 2	ST L No output ST R +10 +/- 2	C-R L No output C-R R 0 +/- 2

*1: Turn on the PFL switch when measuring the C-R OUT.

1) The difference in the level between the following should be less than 2 dB: GROUP (1 to 4) OUT; AUX (1 to 4) OUT; and ST (L,R) OUT.

Table 10: Input terminal TAPE IN L R

[Unit: dBs]

Input	Input Level	ST L OUT	ST R OUT	C-R L OUT	C-R R OUT	PHONES L	PHONES R
TAPE IN L	-7.8	+20 +/- 2 *1	-	+10 +/- 2 *2	-	*, ** -1 +/- 2 *3	-
TAPE IN R		-	+20 +/- 2 *1	-	+10 +/- 2 *2	-	*, ** -1 +/- 2 *3

*1 Set the TAPE IN ON switch to ON and the TAPE IN VR at maximum.

*2 Set the C-R MONITOR LEVEL VR at maximum and the PFL.AFL/TAPE IN switch to ON.

*3 Set the PHONES VR at maximum and the PFL.AFL/TAPE IN switch to ON.

Table 11: Input Terminal ST INSERT IN

[Unit: dBs]

Input	Input Level	ST L OUT	ST R OUT
ST INSERT L	-10	+4 +/- 2	-
ST INSERT R		-	+4 +/- 2

1) The level difference between ST (L, R) OUT should be 2 dB or less.

2-2 Frequency Response

With the input signal frequency is set to 20 Hz and 20 kHz in the state as described in 2-15, check the level at each output terminal marked with an asterisk (*) in Table 1, Table 3, Table 6, Table 8, Table 9, and Table 10. It should fall within the range of +1 dB and -2 dB, using 1 kHz as a reference.

2-3 Equalizer Characteristics

With each EQ control moved in the state as described in 1-1, check the output level of each frequency obtained at GROUP 1 OUT (GROUP 1, 2 OUT for ST INPUT). It should be within the range shown in Tables 12 and 13 with the output level at the center click position of the EQ GAIN control (this should be the reference point).

Table 12: CH INPUT (1-8; 12; 20) EQ [Unit: dBs]

EQ	GAIN	f-VR	Input Signal Frequency	Response
HI	Maximum	-	10 kHz	+12 +/- 2
	Minimum			-12 +/- 2
MID	Maximum	Minimum	250 Hz	+15 +/- 2.5
	Minimum			-15 +/- 2.5
	Maximum	Maximum	5 kHz	+15 +/- 2.5
	Minimum			-15 +/- 2.5
LOW	Maximum	-	100 Hz	+12 +/- 2
	Minimum			-12 +/- 2

Table 13: ST INPUT (9 to 12, 13 to 16, 21 to 24) EQ [Unit: dB]

EQ	GAIN	Input Signal Frequency	Response
HI	Maximum	10 kHz	+12 +/- 2
	Minimum		-12 +/- 2
MID	Maximum	2.5 kHz	+15 +/- 2.5
	Minimum		-15 +/- 2.5
LOW	Maximum	100 Hz	+12 +/- 2
	Minimum		-12 +/- 2

2-4 HPF Variation Characteristics

In status 1-1, if the applied signal is 80 Hz and the HPF switch of the INPUT CH is switched ON, the output level of GROUP OUT 1 should be within -3 +/- 2 dB, using the level when HPF is OFF as the reference.

However, when measuring the ST INPUT, check the output level of GROUP 1 OUT for the L input and that of GROUP 2 OUT for the R input.

2-5 Separation

With AUX SEND VR of CH1 and AUX 1, 2 fader set to the nominal position, check that the leakage level of AUX 2 OUT is -50 dB or less when a +20 dB is obtained at AUX 1 OUT.

With AUX 2 SEND VR of CH1 and AUX 1, 2 fader set to the nominal position, check that the leakage level of AUX 1 OUT is -50 dB or less when a +20 dB is obtained at AUX 2 OUT.

Check similarly between AUX 3 and AUX 4, and between AUX 5 and AUX 6.

2-6 PEAK LED Lighting Level

Check that PEAK LED lights up at the input signal level, as specified in Table 14, when a signal is applied to the CH INPUT or the ST CH INPUT in the state as described in 1-1.

Table 14: PEAK LED [Unit : dBs]

Input	CH INPUT	ST CH INPUT *1
Input Signal Level	-43 +/- 2	-17 +/- 2

*1: Perform this check both when inputting a signal to the L CH (insert a blank jack into R CH) and when inputting a signal to R CH.

2-7 METER LED Lighting Level

Check that the METER SELECT switch is turned on, and that each METER LED lights up when the output level of GROUP within the range listed in (1 to 4) is Table 15.

Table 15: METER LED [Unit : dBs]

LED Name	Lighting Start Level
PEAK	+17 +/- 2
+8	+12 +/- 2
+5	+9 +/- 2
+3	+7 +/- 2
+1	+5 +/- 2
0	+4 +/- 2
-1	+3 +/- 2
-3	+1 +/- 2
-5	-1 +/- 2
-7	-3 +/- 2
-10	-6 +/- 3
-15	-11 +/- 4
-20	-16 +/- 5

* When the METER SELECT switch is turned off, check that "0" of the ST OUT L R LED lights up when the ST OUT L R level is +4; +/- 2; and "0" and that the PFL•AFL/TAPE IN L R LED lights up when the C-R (L, R) OUT level is +10 +/- 2.

2-8 Distortion

Set each fader of the INPUT and MASTER to the Nominal Position in the state of 1.1.

Check at each output terminal that the distortion is 0.1% or less when an output or +14 dBs is obtained at 20 Hz, 1 kHz and 20 kHz in the system of marked [**] in Table 1, Table 3, Table 6, Table 9, and Table 10.

Also, when both an output of +3 dBs is obtained at PHONES OUT and an output of + 2.2 dBs is obtained at REC OUT, the distortion factor should be less than 0.1 %.

2-9 Maximum Output Level

Check that a +24 dBs output is obtained with the distortion factor of 1% or less at AUX (1 - 6) OUT, ST (L, R) OUT and MONO OUT in the state as described in 1-1.

Also, check that a +20 dBs output is obtained with the distortion factor of 1% or less at GROUP (1 - 4) OUT and C - R (L, R) OUT, and that a +8 dBs output with the distortion factor of 1% or less is obtained at PHONES (L, R) OUT.

2-10 Noise Level

Check the noise level that is obtained at GROUP 1 OUT when only the fader and the GAIN trim of the INPUT CH measuring are set to "MAX" and the other INPUT CHs are set to "MIN" in the state as described in 1-1, adjust it to -43 dBs or less.

If the noise level exceeds -43 dBs, use the input conversion method to obtain the noise level. A noise level of -127 dBs or lower is acceptable.

(Use a DIN AUDIO FILTER and an average response level.)

2-11 Residual Noise

Set all fader level controls in the INPUT unit to minimums as described in H. At this time, with the fader level control in the MASTER unit set to maximum or minimum, the noise level should be as specified in Table 16 or less.

(Use a DIN AUDIO FILTER and an average response level.)

Table 16 : Residual Noise

[Unit : dBs]

FADER & VR	GROUP 1-4 OUT	AUX 1-4 OUT	ST L, R OUT	C-R L, R OUT	MONO OUT
MAX	-77	-72	-76	-78	-79
MIN	-94	-97	-97	-99	-95

*1) Turn off the POST switch when measuring the MONO OUT.

2-12 FADER Maximum Attenuation

With each fader set to "MAX," obtain a +20 dBs output at each output terminal and adjust the attenuation to be -60dB or less when each fader in the CH INPUT, ST CH INPUT and MASTER sections is turned down fully.

As the ST INPUT and ST MASTER faders are linked, check both the L and R sides.

(Measurement can be taken by using a DIN audio filter and reducing the noise.)

2-13 Phase

Check that the signal input into each input terminal and the signal output from each output terminal have the same phase.

Pin assignment for the balance type input/output terminal

- pin 1 --- GND
- pin 2 --- + (HOT)
- pin 3 --- - (COLD)

2-14 Phantom Power (+48 V)

Connect a loading resistor of 10 k ohms (1 W minimum or more) between pins (1) and (2) of MIC IN ,and create a short between pins (2)

and (3). Check that a +35 \pm 3 V DC voltage is obtained between both ends of the loading resistor when the PHANTOM switch is turned on. Also check that the PHANTOM LED is lit.

2-15 Stability

Check that the operation is free from abnormality even when the power voltage varies \pm 10 %.

Connect a capacitor of 10 PF - 0.1 μ F in parallel to the loading resistor at each output terminal, and check that no abnormality such as oscillation occurs.

Check that no abnormality such as oscillation occurs when the fader, level control and EQ are all set to "maximum" and the input terminal is shorted by 150 ohms.

2-16. Settings prior to Shipment

EQ GAIN	CENTER
PAN, BAL VR	CENTER
VR other than the above	Minimum
All push switches	OFF
All faders	Minimum
PHANTOM switch	OFF

GF24/12
GF16/12
GF12/12

GF24/12
GF16/12
GF12/12

GF24/12
GF16/12
GF12/12

GF24/12
GF16/12
GF12/12

GF24/12
GF16/12
GF12/12

MIXING CONSOLE

GF24/12

GF16/12

GF12/12

PARTS LIST

CONTENTS

GF 24/12 OVERALL ASSEMBLY	2
GF 16/12 OVERALL ASSEMBLY	4
GF 12/12 OVERALL ASSEMBLY	6
GF 24/12 PANEL ASSEMBLY	8
GF 16/12 PANEL ASSEMBLY	8
GF 12/12 PANEL ASSEMBLY	9
GF 24/12 REAR PANEL ASSEMBLY	10
GF 16/12 REAR PANEL ASSEMBLY	11
GF 12/12 REAR PANEL ASSEMBLY	11
ELECTRICAL PARTS	12

Notes : DESTINATION ABBREVIATIONS

A : Australian model	J : Japanese model
B : British model	U : U.S. model
C : Canadian model	V : General export model (110 V)
E : European model	W : General export model (220 V)
H : North European model	X : General export model
I : Indonesian model	Y : Export model

■ WARNING

Components having special characteristics are marked  and must be replaced with parts having specification equal to those originally installed.

- The numbers "QTY" show quantities for each unit.
- The parts with "--" in "PART NO." are not available as spare parts.

GF24/12 OVERALL ASSEMBLY

REF NO.	PART NO.	DESCRIPTION		REMARKS	QTY	RANK
		OVERALL ASSEMBLY		GF24-12		
	--	Overall Assembly		J (V329380)		
	--	Overall Assembly		U,V (V329390)		
	--	Overall Assembly		H,W (V329400)		
	--	Overall Assembly		B (V329410)		
* 10	V3288600	Bottom Assembly				
10a	--	Bottom Case				
10b	VV085600	Leg		(V328850)	6	01
10c	VR138400	Bind Head Tapping Screw-B	4.0X12 MFZN2BL		6	01
* 10d	V3461700	Cover	PP.T=0.46		2	
* 20	V3292700	Panel Support			2	
30	EG340190	Bind Head Tapping Screw-B	4.0X8 MFZN2BL		6	01
40	--	Power Supply Assembly		J,U,V (V329020)		
40	--	Power Supply Assembly		H,W,B (V329030)		
50	EG340190	Bind Head Tapping Screw-B	4.0X8 MFZN2BL		4	01
60	VZ765100	Cord Binder	TS-0708 KSS		3	02
70	--	Rear Panel Assembly		J (V329120)		
70	--	Rear Panel Assembly		U,V (V329130)		
70	--	Rear Panel Assembly		H,W (V329140)		
70	--	Rear Panel Assembly		B (V329150)		
80	--	Panel Assembly		(V328890)		
90	EP600190	Bind Head Tapping Screw-B	3.0X8 MFZN2BL		10	01
100	EG340190	Bind Head Tapping Screw-B	4.0X8 MFZN2BL		18	01
110	EP600190	Bind Head Tapping Screw-B	3.0X8 MFZN2BL		6	01
120	EG340190	Bind Head Tapping Screw-B	4.0X8 MFZN2BL		8	01
130	VR138400	Bind Head Tapping Screw-B	4.0X12 MFZN2BL		2	01
* 140	V3292800	Corner Pad	F		2	
150	VS205900	Bind Head Tapping Screw-B	4.0X20 MFZN2BL		2	01
* 160	V3292900	Corner Pad	R		2	
170	VS205900	Bind Head Tapping Screw-B	4.0X20 MFZN2BL		4	01
180	--	Connector Assembly	KR-KR 9P 180L	(V317880)	2	
190	--	Connector Assembly	KR-KR 8P 80L	(V345610)		
200	--	Connector Assembly	2426&2426 7P 750L	(V370530)		
210	--	Connector Assembly	KR-KR 3P 650L	(V317850)		
220	--	Connector Assembly	KR-KR 2P 500L	(V370260)		
225	--	Connector Assembly	KR-KR 2P 60L	(V317830)		
230	--	Connector Assembly	KR-KR 12P 40L	(V320110)		
240	--	Connector Assembly	KR-KR 7P 40L	(V362110)	2	
* 250	V3178900	Cable	FBNCDP=1.25K-35-60		5	02
* 260	V3702400	Cable	FBNCDP=1.25K-20-80		2	
270	--	Meter Assembly		(V328970)		
* 270a	V3289600	Meter Case				
270b	EP630220	Bind Head Tapping Screw-P	3.0X8 MFZN2BL		4	01
280	VQ074600	Bind Head Tapping Screw-B	3.0X12 MFZN2BL		2	01
290	EG340190	Bind Head Tapping Screw-B	4.0X8 MFZN2BL		6	01
300	VP156800	Bind Head Screw	A4.0X8 MFZN2BL	J	2	01
300	VP156800	Bind Head Screw	A4.0X8 MFZN2BL	U,V,H,W,B	3	01
310	--	Connector Assembly	KR-KR 10P 180L	(V343740)		
320	--	Label		U,V (VA03930)		
		POWER SUPPLY ASSEMBLY		GF24-12		
	--	Power Supply Assembly		J,U,V (V329020)		
	--	Power Supply Assembly		H,W,B (V329030)		
* P10	V3289900	Heat Sink				
* P20	V3290000	Heat Radiation Sheet	0NISHEET T=0.15			
P30	--	Circuit Board	DC	J,U,V (V288460,XV338B0)		
P30	--	Circuit Board	DC	H,W,B (V288470,XV338B0)		
* P30a	AA X00170	Circuit Board	DC 1/2	J,U,V (V288460,XV338B0)		
* P30a	AA X00190	Circuit Board	DC 1/2	H,W,B (V288470,XV338B0)		
* P30b	AA X00180	Circuit Board	DC 2/2	J,U,V (V288460,XV338B0)		
* P30b	AA X00200	Circuit Board	DC 2/2	H,W,B (V288470,XV338B0)		
P40	EP600190	Bind Head Tapping Screw-B	3.0X8 MFZN2BL		4	01
P50	VQ074600	Bind Head Tapping Screw-B	3.0X12 MFZN2BL			01
P60	--	"Angle, Transistor "		(V329010)		
P70	VQ074600	Bind Head Tapping Screw-B	3.0X12 MFZN2BL		3	01

* : New Parts

RANK : Japan only

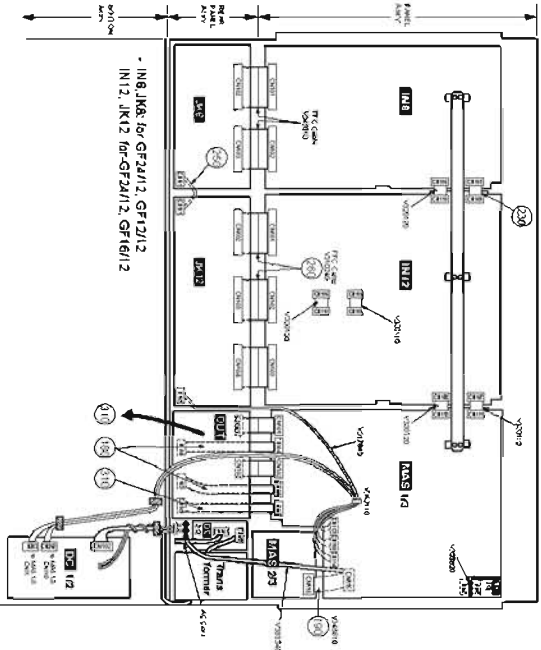
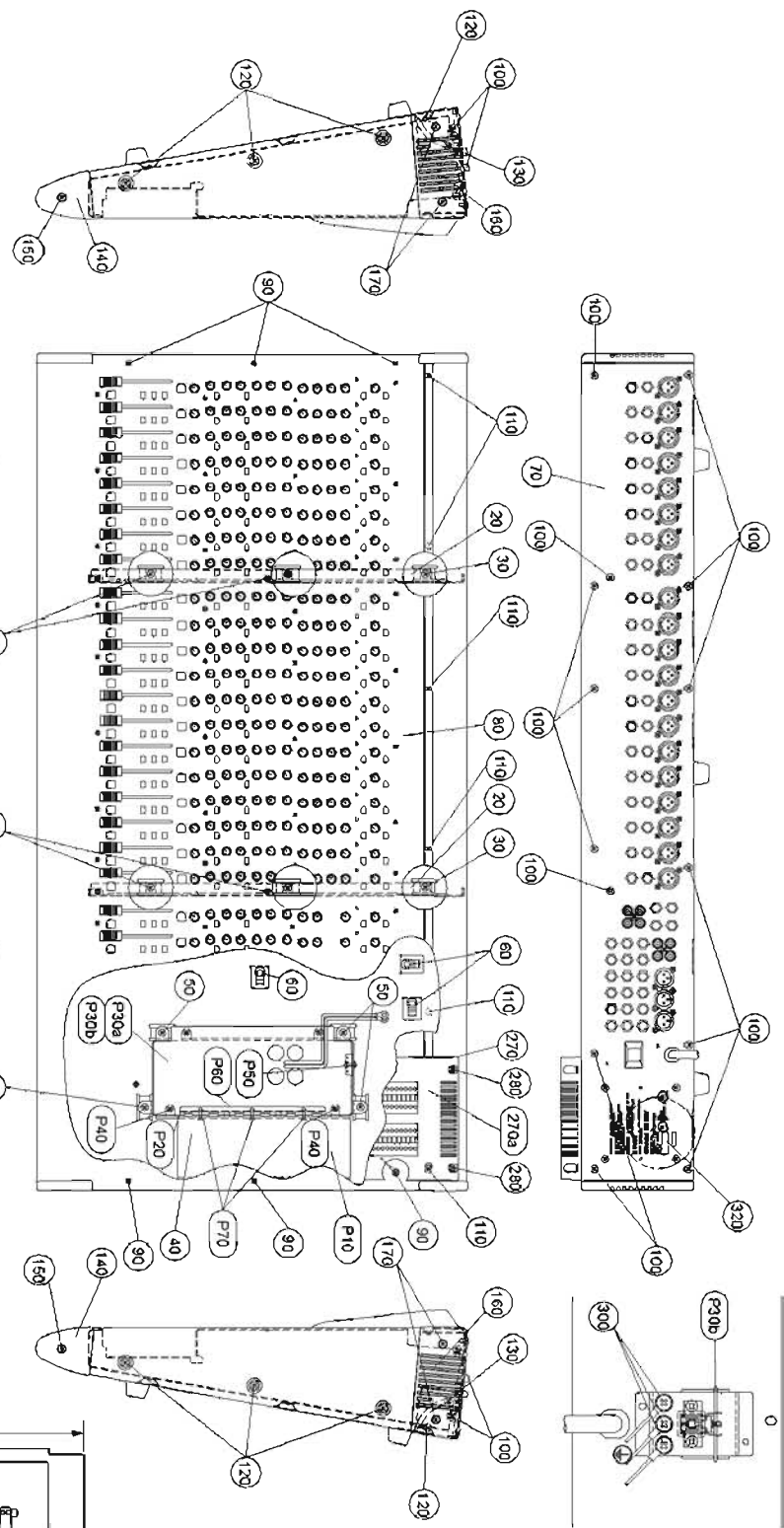

GF16/12 OVERALL ASSEMBLY

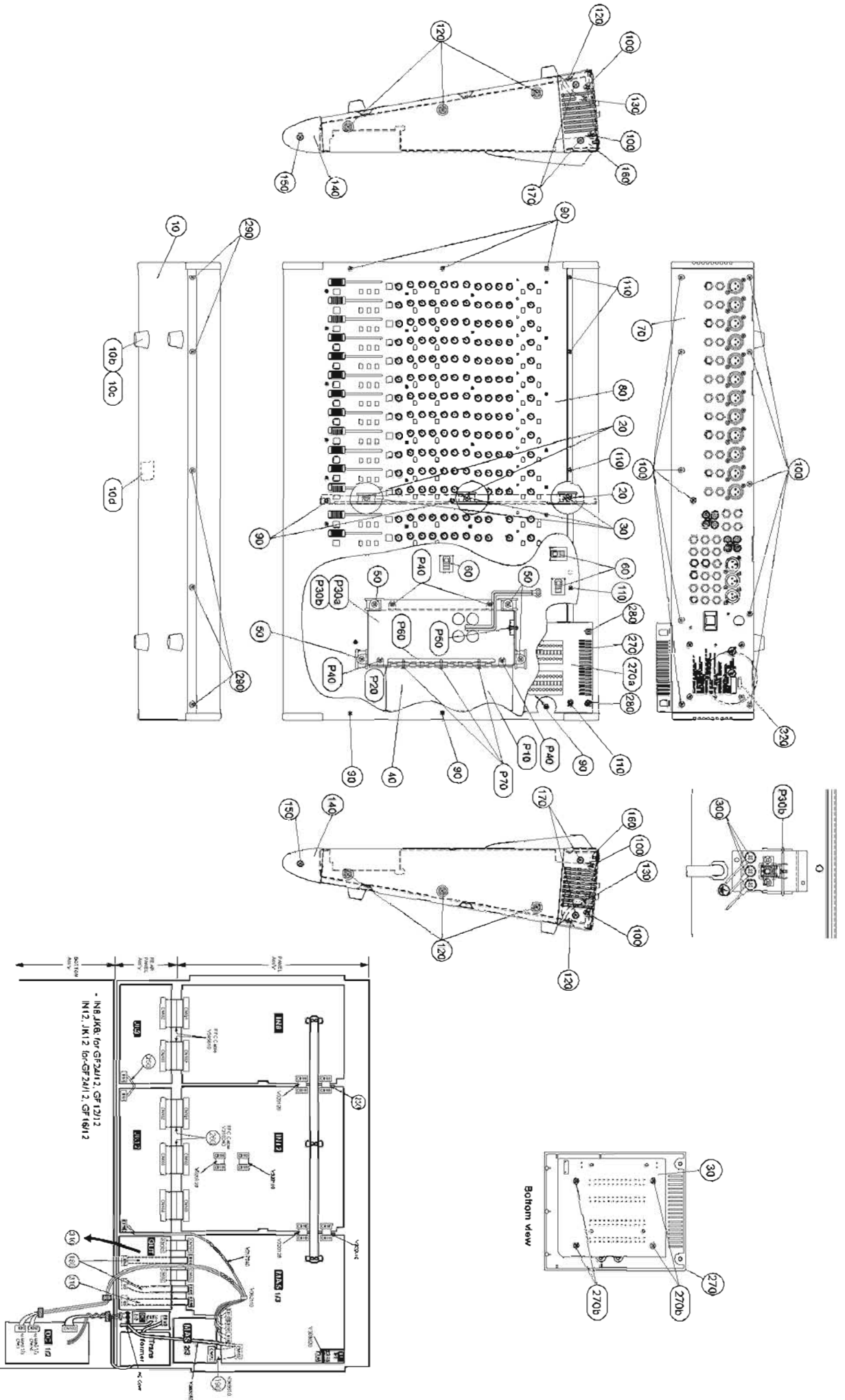

REF NO.	PART NO.	DESCRIPTION		REMARKS	QTY	RANK
		OVERALL ASSEMBLY		GF16-12		
	--	Overall Assembly		J (V329340)		
	--	Overall Assembly		U,V (V329350)		
	--	Overall Assembly		H,W (V329360)		
	--	Overall Assembly		B (V329370)		
* 10	V3288400	Bottom Assembly				
10a	--	Bottom Case		(V328830)		
10b	VV085600	Leg			4	01
10c	VR138400	Bind Head Tapping Screw-B	4.0X12 MFZN2BL		4	01
* 10d	V3461700	Cover	PP.T=0.46			
* 20	V3292700	Panel Support				
30	EG340190	Bind Head Tapping Screw-B	4.0X8 MFZN2BL		3	01
40	--	Power Supply Assembly	J U	J,U,V (V329020)		
40	--	Power Supply Assembly	H B	H,W,B (V329030)		
50	EG340190	Bind Head Tapping Screw-B	4.0X8 MFZN2BL		4	01
60	VZ765100	Cord Binder	TS-0708 KSS		3	02
70	--	Rear Panel Assembly		J (V329080)		
70	--	Rear Panel Assembly		U,V (V329090)		
70	--	Rear Panel Assembly		H,W (V329100)		
70	--	Rear Panel Assembly		B (V329110)		
80	--	Panel Assembly		(V328880)		
90	EP600190	Bind Head Tapping Screw-B	3.0X8 MFZN2BL		8	01
100	EG340190	Bind Head Tapping Screw-B	4.0X8 MFZN2BL		15	01
110	EP600190	Bind Head Tapping Screw-B	3.0X8 MFZN2BL		5	01
120	EG340190	Bind Head Tapping Screw-B	4.0X8 MFZN2BL		8	01
130	VR138400	Bind Head Tapping Screw-B	4.0X12 MFZN2BL		2	01
* 140	V3292800	Corner Pad			2	
150	VS205900	Bind Head Tapping Screw-B	4.0X20 MFZN2BL		2	01
* 160	V3292900	Corner Pad			2	
170	VS205900	Bind Head Tapping Screw-B	4.0X20 MFZN2BL		4	01
180	--	Connector Assembly	KR-KR 9P 180L	(V317880)	2	
190	--	Connector Assembly	KR-KR 8P 80L	(V345610)		
200	--	Connector Assembly	2426&2426 4P 750L	(V370530)		
210	--	Connector Assembly	KR-KR 3P 650L	(V317850)		
220	--	Connector Assembly	KR-KR 2P 500L	(V370260)		
230	--	Connector Assembly	KR-KR 12P 40L	(V320110)		
240	--	Connector Assembly	KR-KR 7P 40L	(V362110)		
* 250	V3702400	Cable	FBNCDP=1.25K-35-60		3	
* 260	V3179000	Cable	FBNCDP=1.25K-20-60		2	
270	--	Meter Assembly		(V328970)		
* 270a	V3289600	Meter Case				
270b	EP630220	Bind Head Tapping Screw-P	3.0X8 MFZN2BL		4	01
280	VQ074600	Bind Head Tapping Screw-B	3.0X12 MFZN2BL		2	01
290	EG340190	Bind Head Tapping Screw-B	4.0X8 MFZN2BL		5	01
300	VP156800	Bind Head Screw	A4.0X8 MFZN2BL	J	2	01
300	VP156800	Bind Head Screw	A4.0X8 MFZN2BL	U,V,H,W,B	3	01
310	--	Connector Assembly	KR-KR 10P 180L	(V343740)		
320	--	Label		U,V (VA03930)		
		POWER SUPPLY ASSEMBLY		GF16-12		
	--	Power Supply Assembly		J,U,V (V329020)		
	--	Power Supply Assembly		H,W,B (V329030)		
* P10	V3289900	Heat Sink				
* P20	V3290000	Heat Radiation Sheet	0NISHEET T=0.15			
P30	--	Circuit Board	DC	J,U,V (V288460,XV338B0)		
P30	--	Circuit Board	DC	H,W,B (V288470,XV338B0)		
* P30a	AA00170	Circuit Board	DC 1/2	J,U,V (XV338B0)		
* P30a	AA00190	Circuit Board	DC 1/2	H,W,B (XV338B0)		
* P30b	AA00180	Circuit Board	DC 2/2	J,U,V (XV338B0)		
* P30b	AA00200	Circuit Board	DC 2/2	H,W,B (XV338B0)		
P40	EP600190	Bind Head Tapping Screw-B	3.0X8 MFZN2BL		4	01
P50	VQ074600	Bind Head Tapping Screw-B	3.0X12 MFZN2BL			01
P60	--	Angle, Transistor		(V329010)		
P70	VQ074600	Bind Head Tapping Screw-B	3.0X12 MFZN2BL		3	01

*: New Parts

RANK : Japan only

GF12/12 OVERALL ASSEMBLY

REF NO.	PART NO.	DESCRIPTION		REMARKS	QTY	RANK
		OVERALL ASSEMBLY		GF12-12		
	--	Overall Assembly		J (V329300)		
	--	Overall Assembly		U,V (V329310)		
	--	Overall Assembly		H,W (V329320)		
	--	Overall Assembly		B (V329330)		
* 10	V3288100	Bottom Assembly				
10a	--	Bottom Case		(V328820)		
10b	VV085600	Leg			4	01
10c	VR138400	Bind Head Tapping Screw-B	4.0X12 MFZN2BL		4	01
* 10d	V3461700	Screw Cover	PP T=0.46			
* 20	V3292700	Panel Support				
30	EG340190	Bind Head Tapping Screw-B	4.0X8 MFZN2BL		3	01
40	--	Power Supply Assembly	J U	J,U,V (V329020)		
40	--	Power Supply Assembly	H B	H,,B (V329030)		
50	EG340190	Bind Head Tapping Screw-B	4.0X8 MFZN2BL		4	01
60	VZ765100	Cord Binder	TS-0708 KSS		3	02
70	--	Rear Panel Assembly		J (V329040)		
70	--	Rear Panel Assembly		U,V (V329050)		
70	--	Rear Panel Assembly		H,W (V329060)		
70	--	Rear Panel Assembly		B (V329070)		
80	--	Panel Assembly		(V328870)		
90	EP600190	Bind Head Tapping Screw-B	3.0X8 MFZN2BL		8	01
100	EG340190	Bind Head Tapping Screw-B	4.0X8 MFZN2BL		13	01
110	EP600190	Bind Head Tapping Screw-B	3.0X8 MFZN2BL		4	01
120	EG340190	Bind Head Tapping Screw-B	4.0X8 MFZN2BL		8	01
130	VR138400	Bind Head Tapping Screw-B	4.0X12 MFZN2BL		2	01
* 140	V3292800	Corner Pad	F		2	
150	VS205900	Bind Head Tapping Screw-B	4.0X20 MFZN2BL		2	01
* 160	V3292900	Corner Pad	R		2	
170	VS205900	Bind Head Tapping Screw-B	4.0X20 MFZN2BL		4	01
180	--	Connector Assembly	KR-KR 9P 180L	(V317880)	2	
190	--	Connector Assembly	KR-KR 8P 80L	(V345610)		
200	--	Connector Assembly	2426&2426 7P 750L	(V370530)		
210	--	Connector Assembly	KR-KR 3P 650L	(V317850)		
220	--	Connector Assembly	KR-KR 2P 500L	(V370260)		
230	--	Connector Assembly	KR-KR 12P 40L	(V320110)		
240	--	Connector Assembly	KR-KR 7P 40L	(V362110)		
* 250	V3178900	Cable	FBNCDP=1.25K-35-60		2	
* 260	V3702400	Cable	FBNCDP=1.25K-20-80		2	
270	--	Meter Assembly		(V328970)		
* 270a	V3289600	Meter Case				
270b	EP630220	Bind Head Tapping Screw-P	3.0X8 MFZN2BL		4	01
280	VQ074600	Bind Head Tapping Screw-B	3.0X12 MFZN2BL		2	01
290	EG340190	Bind Head Tapping Screw-B	4.0X8 MFZN2BL		4	01
300	VP156800	Bind Head Screw	A4.0X8 MFZN2BL	J	2	01
300	VP156800	Bind Head Screw	A4.0X8 MFZN2BL	U,V,H,W,B	3	01
310	--	Connector Assembly	KR-KR 10P 180L	(V343740)		
320	--	Label		U,V (VA03930)		
		POWER SUPPLY ASSEMBLY		GF12-12		
	--	Power Supply Assembly		J,U,V (V329020)		
	--	Power Supply Assembly		H,B,W (V329030)		
* P10	V3289900	Heat Sink				
* P20	V3290000	Heat Radiation Sheet	0NISHEET T=0.15			
P30	--	Circuit Board	DC	J,U,V (V288460,XV338B0)		
P30	--	Circuit Board	DC	H,W,B (V288470,XV338B0)		
* P30a	AA X00170	Circuit Board	DC 1/2	J,U,V (V288460,XV338B0)		
* P30a	AA X00190	Circuit Board	DC 1/2	H,W,B (V288470,XV338B0)		
* P30b	AA X00180	Circuit Board	DC 2/2	J,U,V (V288460,XV338B0)		
* P30b	AA X00200	Circuit Board	DC 2/2	H,W,B (V288470,XV338B0)		
P40	EP600190	Bind Head Tapping Screw-B	3.0X8 MFZN2BL		4	01
P50	VQ074600	Bind Head Tapping Screw-B	3.0X12 MFZN2BL			01
P60	--	Angle, Transistor		(V329010)		
P70	VQ074600	Bind Head Tapping Screw-B	3.0X12 MFZN2BL		3	01

* : New Parts

RANK : Japan only

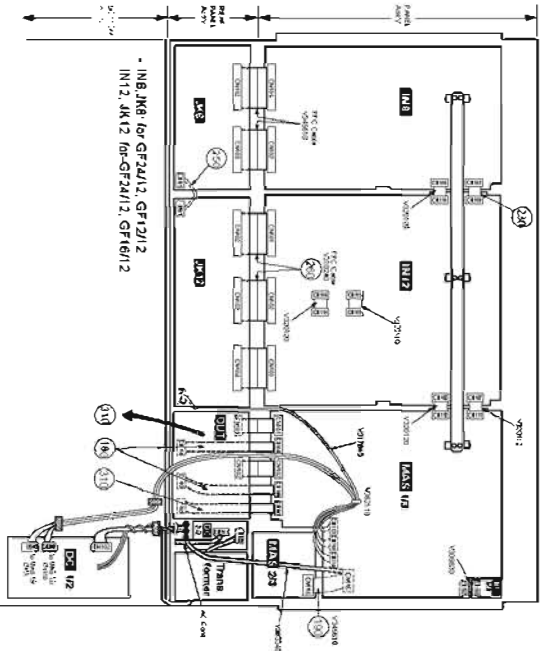
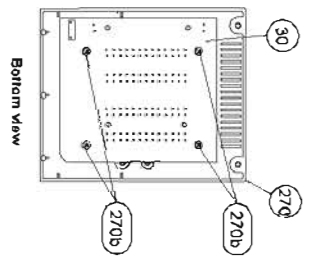
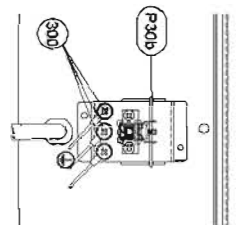
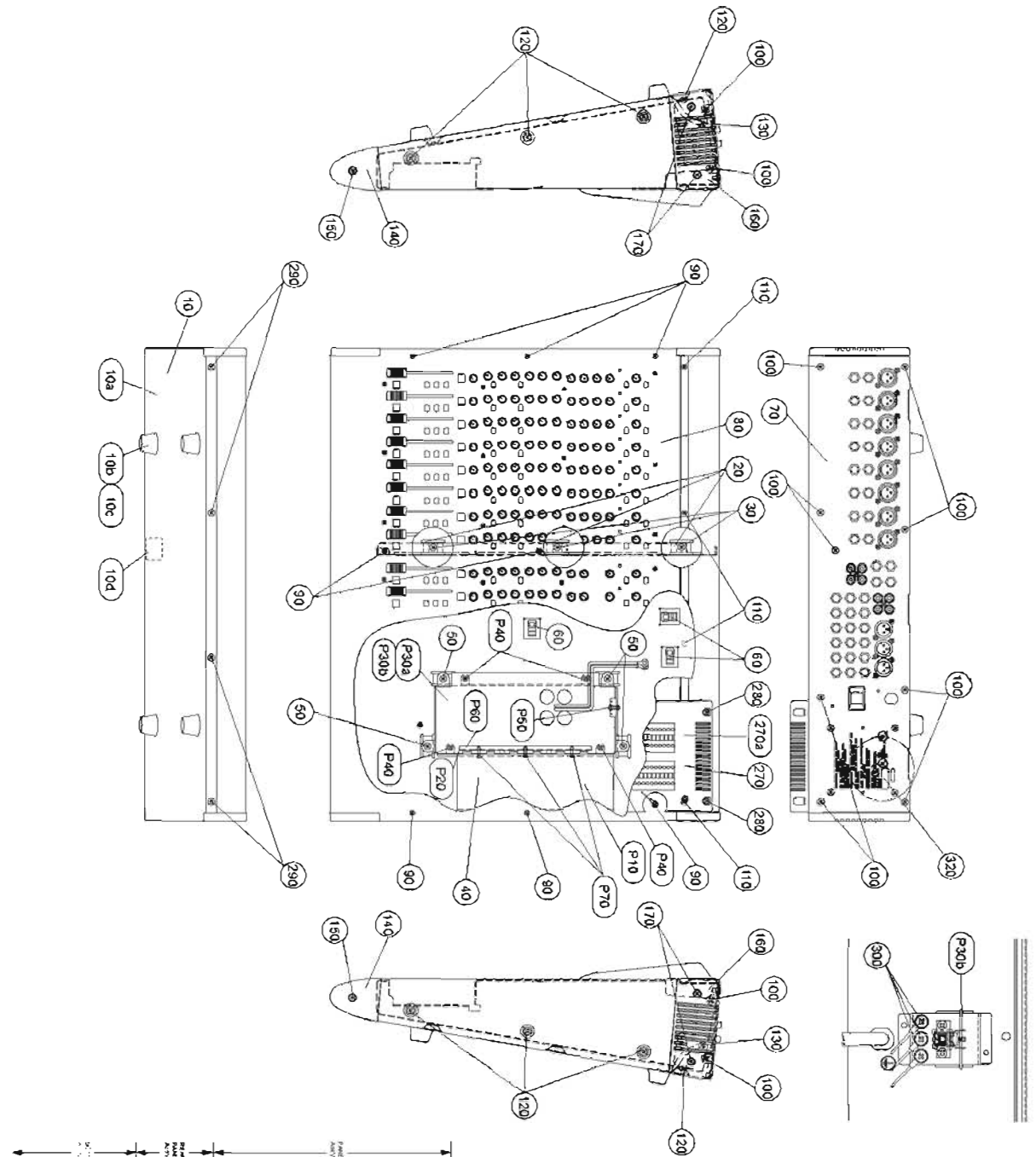

GF24/12 PANEL ASSEMBLY

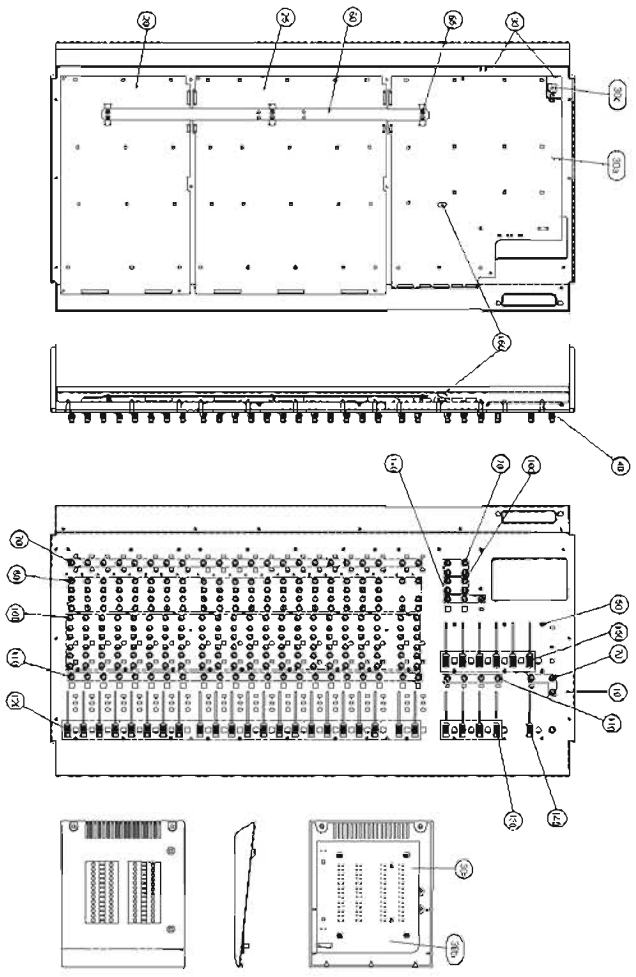

REF. NO.	PART NO.	DESCRIPTION	REMARKS	QTY	UNIT
10	V3289280	Panel	(V328930)		
11	V2884006	Circuit Board	(V328280) (XV33330)		
20	V2884100	Circuit Board	(V328280) (XV33330)		
25	V2884100	Circuit Board	(V328280) (XV33330)		
30	AA300110	Circuit Board	MAS 1/2 (V288420 XV33480)		
30B	AA300120	Circuit Board	MAS 1/3 (V288420 XV33480)		
30C	AA300130	Circuit Board	MAS 2/3 (V288420 XV33480)		
40	V3291600	Support	NEW MFCO BL 3X25 MFX2BL	48	01
50	V3289800	Screw	3X25 MFX2BL	48	01
50	...	Screw	(V328930)		
60	ED340086	Brnd Head Screw	4.0X8 MFX2BL	6	01
65	VUB59700	Knob	N-GRAVD-GRAY	29	01
80	VUB62700	Knob	MAX-GREEND-GRAY	86	01
100	VUB69300	Knob	MAX-BLUED-GRAY	136	01
110	VUB60400	Knob	REDID-GRAY	29	01
120	VUB60500	Fader Knob	BLACK/CL-GRAY		
130	VV135600	Fader Knob	RED/CD-GRAY	22	01
140	V2846600	Fader Knob	CL-GRAY/RED	4	01
150	V2846600	Fader Knob	BLACK/CL-BLUE	01	01
160	VV903200	Con'd Drive	KVS-1 KSS	6	01

New Parts

RANK Japan only

GF16/12 PANEL ASSEMBLY

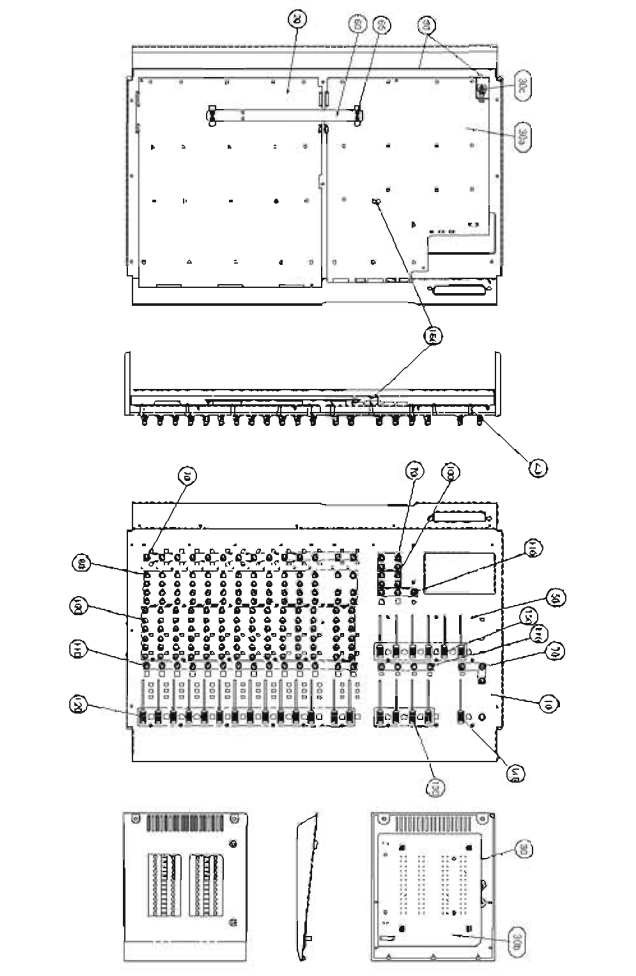

REF. NO.	PART NO.	DESCRIPTION	REMARKS	QTY	UNIT
10	V3289100	Panel	(V328930)		
11	V2884100	Circuit Board	(V328280) (XV33330)		
20	V2884100	Circuit Board	(V328280) (XV33330)		
25	V2884100	Circuit Board	(V328280) (XV33330)		
30	AA300110	Circuit Board	MAS 1/2 (V288420 XV33480)		
30B	AA300120	Circuit Board	MAS 1/3 (V288420 XV33480)		
30C	AA300130	Circuit Board	MAS 2/3 (V288420 XV33480)		
40	V3291600	Support	NEW MFCO BL 3X25 MFX2BL	36	01
50	V3289800	Screw	3X25 MFX2BL	36	01
50	...	Screw	(V328930)		
60	ED340086	Brnd Head Screw	4.0X8 MFX2BL	4	01
65	VUB59700	Knob	N-GRAVD-GRAY	21	01
80	VUB60200	Knob	MAX-GREENID-GRAY	54	01
100	VUB60300	Knob	MAX-BLUED-GRAY	88	01
110	VUB60400	Knob	REDID-GRAY	21	01
120	VUB60500	Fader Knob	BLACK/CL-GRAY		
130	VV135600	Fader Knob	RED/CD-GRAY	14	01
140	V2846600	Fader Knob	CL-GRAY/RED	4	01
150	V2846600	Fader Knob	BLACK/CL-BLUE	01	01
160	VV903200	Con'd Drive	KVS-1 KSS	6	01

New Parts

RANK Japan only

GF12/12 PANEL ASSEMBLY

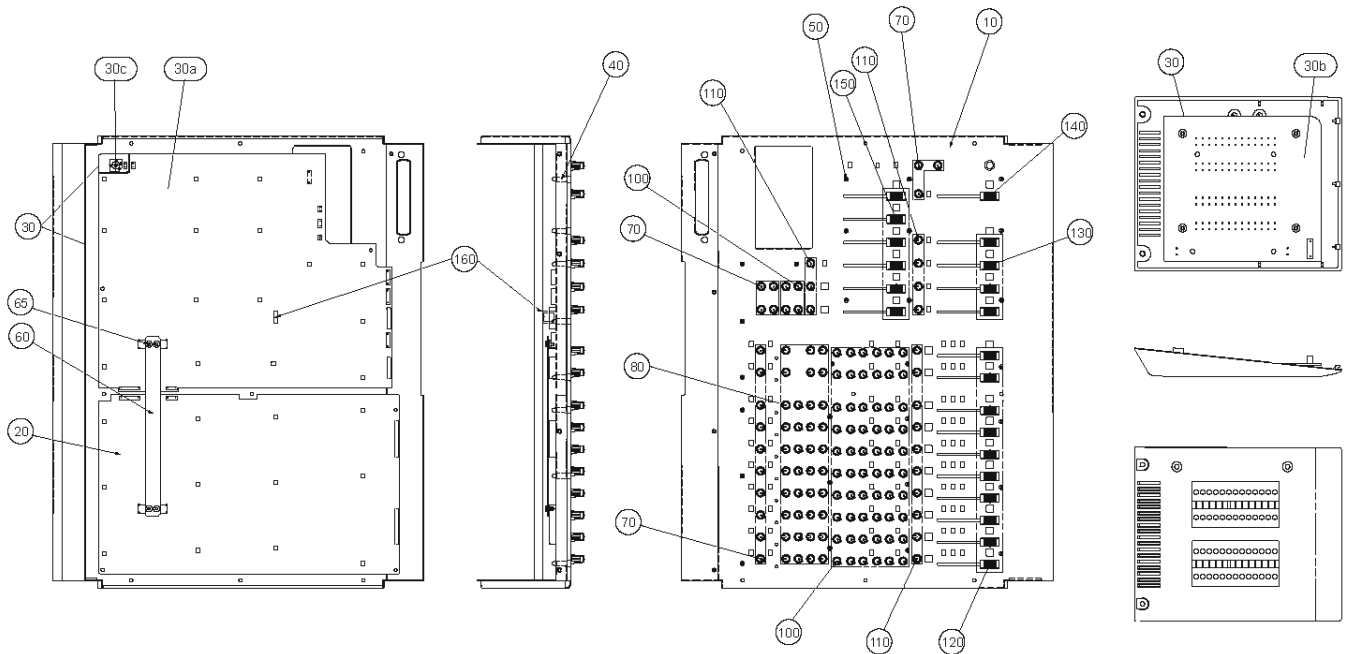

REF NO.	PART NO.	DESCRIPTION		REMARKS	QTY	RANK
	--	PANEL ASSEMBLY		GF12-12		
	--	Panel Assembly		(V328870)		
* 10	V3289000	Panel		(XV332B0)		
* 20	V2884000	Circuit Board	IN8	(V288420,XV334B0)		
* 30	--	Circuit Board	MAS	(V288420,XV334B0)		
30a	AAX00110	Circuit Board	MAS 1/3	(V288420,XV334B0)		
* 30b	AAX00120	Circuit Board	MAS 2/3	(V288420,XV334B0)		
* 30c	AAX00130	Circuit Board	MAS 3/3	(V288420,XV334B0)		
* 40	V3291600	Support	NEW NIFCO BL		28	01
50	V3289800	Screw	3X25 MFZNBL		28	01
60	--	Earth Bar		(V328930)		
65	ED340086	Bind Head Screw	4.0X8 MFZN2BL		4	01
70	VU859700	Knob	N-GRAY/D-GRAY	GAIN(1-12ch),AUX RETURN 1,2(GROUP1-4),STEREO (MONO),C-R MONI LEVEL, PHONES LEVEL	17	01
80	VU860200	Knob	MX-GREEN/D-GRAY	PEAK(1-12ch:HIGH,MID, LOW)	38	01
100	VU860300	Knob	MX-BLUE/D-GRAY	AUX1-6(1-12ch),AUX RETURN 1,2(AUX1-4)	64	01
110	VU860400	Knob	RED/D-GRAY	PAN(1-8ch,GROUP1-4), BAL.(9-12ch),AUX RETURN1,2 (ST),TAPE IN(ST),	17	01
120	VU860500	Fader Knob	BLACK/CL-GRAY	1-12ch	10	01
130	VV135600	Fader Knob	RED/CD-GRAY	GROUP1-4	4	01
140	VU860600	Fader Knob	CL-GRAY/RED	STEREO		01
150	V2946900	Fader Knob	BLACK/MX-BLUE	AUX1-6	6	01
160	VV903200	Cord Binder	KWS-1 KSS			01

* : New Parts

RANK : Japan only

GF24/12
GF16/12
GF12/12

GF24/12 REAR PANEL ASSEMBLY

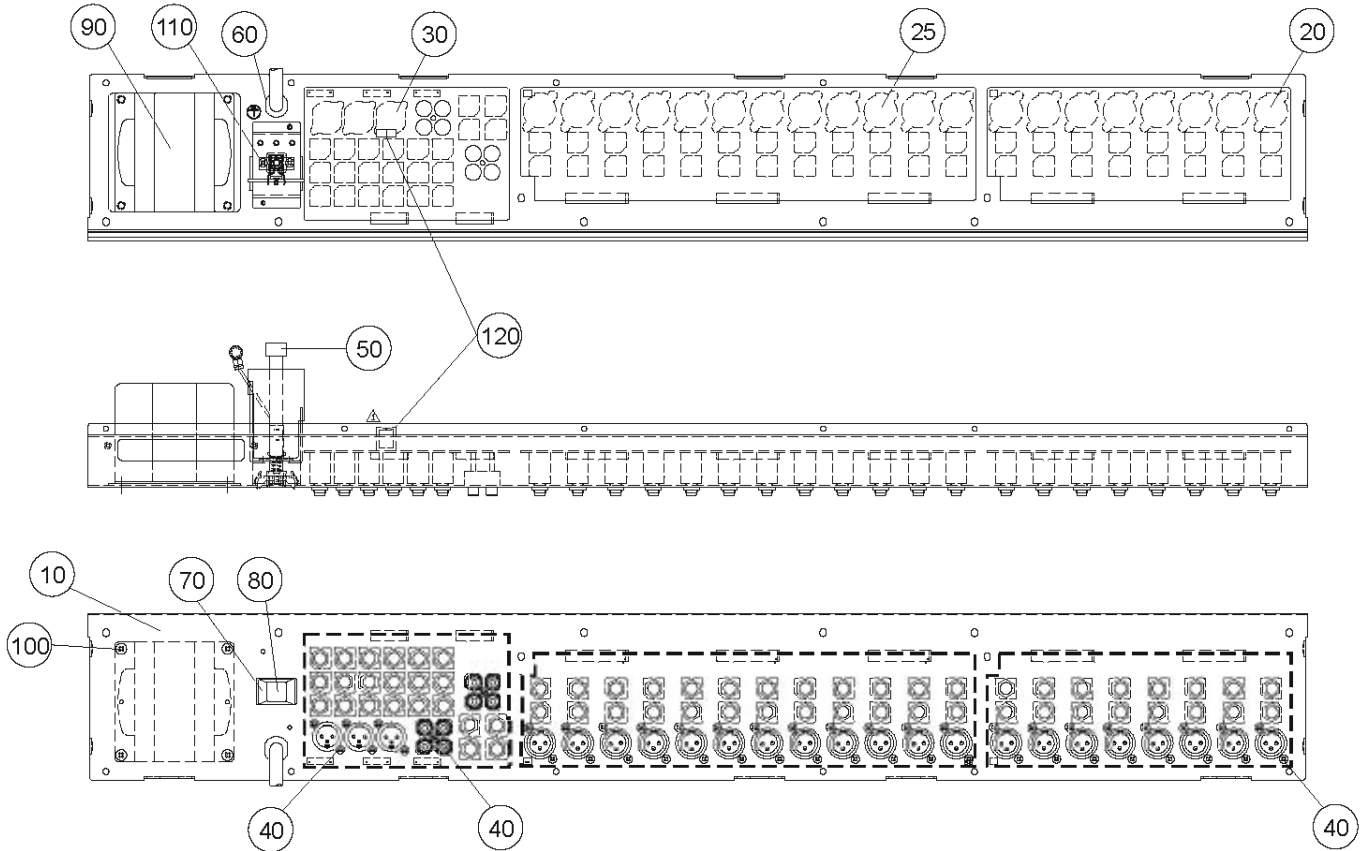

REF NO.	PART NO.	DESCRIPTION	REMARKS	QTY	RANK
		REAR PANEL ASSEMBLY	GF24-12		
	--	Rear Panel Assembly	J (V329120)		
	--	Rear Panel Assembly	U,V (V329130)		
	--	Rear Panel Assembly	H,W (V329140)		
	--	Rear Panel Assembly	B (V329150)		
*	10	V3292300	Rear Panel	J	
*	10	V3292400	Rear Panel	U,V	
*	10	V3292500	Rear Panel	H,W,B	
*	20	AAAX00140	Circuit Board	JK8 (V288430,XV335B0)	
*	25	AAAX00150	Circuit Board	JK12 (V288440,XV336B0)	
*	30	AAAX00160	Circuit Board	OUT (V288450,XV337B0)	
	40	VN413300	Bonding Tapping Screw-B	3.0X8 MFZN2BL	48 01
	50	V3277000	AC Cord	J VCTF 2X0.75 12A	05
	50	VV205600	AC Cord	UC SJT 3X#18 10A	06
	50	V3277100	AC Cord	E H05VV-F3X0.7510A	06
	50	VV058300	AC Cord	BS H05VV-F3X0.75	08
	60	VV103100	Cord Strain Relief	SR-6P1	01
	70	VU859100	Escutcheon, Power Switch		02
	80	VU859000	Power Switch Knob		01
*	90	XV179A00	Power Transformer	J	
*	90	XV180A00	Power Transformer	U,V	
*	90	XV181A00	Power Transformer	H,W,B	
	100	VR138400	Bind Head Tapping Screw-B	4.0X12 MFZN2BL	4 01
	110	EP600190	Bind Head Tapping Screw-B	3.0X8 MFZN2BL	2 01
	120	VV903200	Cord Binder	KWS-1 KSS	01

* : New Parts

RANK : Japan only

GF16/12 REAR PANEL ASSEMBLY

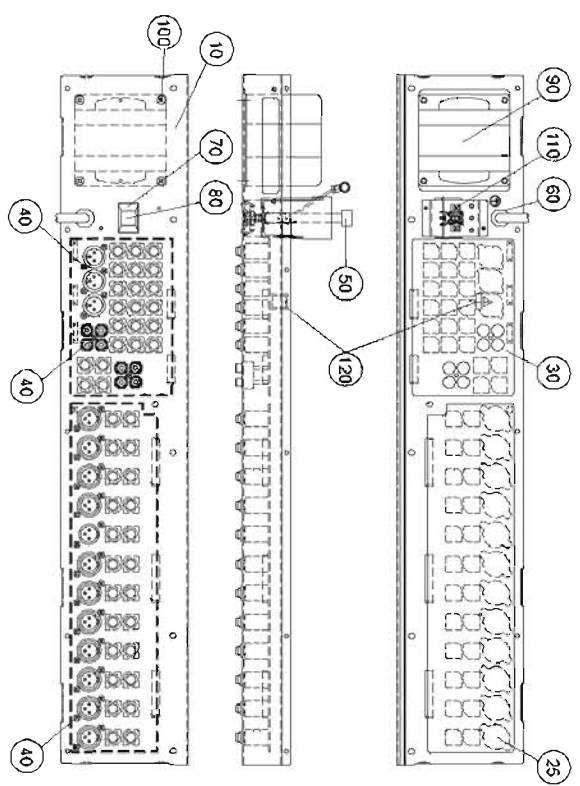

REF. NO.	PART NO.	DESCRIPTION	REMARKS	QTY	UNIT
..	..	REAR PANEL ASSEMBLY	(V329680)	1	J
..	..	REAR PANEL ASSEMBLY	(V329690)	1	U.V
..	..	REAR PANEL ASSEMBLY	(V329100)	1	H.W
..	..	REAR PANEL ASSEMBLY	(V329110)	8	B
..	..	REAR PANEL ASSEMBLY	(V329110)	8	B
10	V3282000	REAR PANEL	(V288440) (V338600)	32	01
..	..	REAR PANEL	(V288450) (V337800)	01	01
10	V3282100	REAR PANEL		01	01
10	V3282200	REAR PANEL		01	01
20	AA300180	CIRCUIT BOARD		1	U.V
20	AA300180	CIRCUIT BOARD		1	H.W.B
30	VN413300	BRANDING TAPPING SCREW B		32	01
40	V3277000	AC CORD		05	05
50	VV206600	AC CORD		06	06
50	V3277100	AC CORD		08	08
50	VV058300	AC CORD		01	01
60	VV103100	COLD STRAIN RELIEF		01	01
70	VU851100	EXHAUSTION POWER SWITCH		02	02
80	VU859000	POWER SWITCH KNOB		01	01
90	XV179A00	POWER TRANSFORMER		1	J
90	XV180A00	POWER TRANSFORMER		1	U.V
90	XV181A00	POWER TRANSFORMER		1	H.W.B
100	VR138400	BRAND HEAD TAPPING SCREW B		4	01
110	EP600190	BRAND HEAD TAPPING SCREW B		1	01
120	VV900200	CORD DIMPERS		2	01

* New Parts

RAIK Japan only

GF12/12 REAR PANEL ASSEMBLY

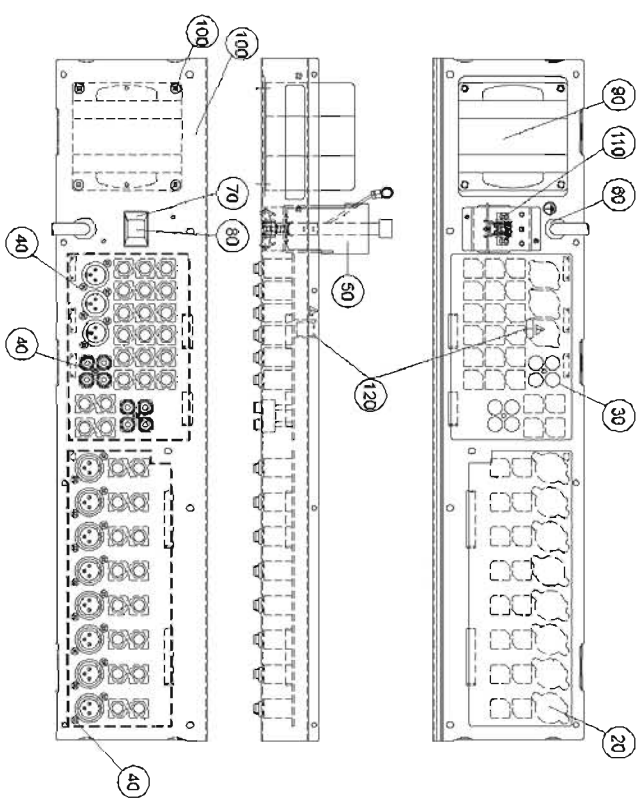

REF. NO.	PART NO.	DESCRIPTION	REMARKS	QTY	UNIT
..	..	REAR PANEL ASSEMBLY	(V325040)	1	J
..	..	REAR PANEL ASSEMBLY	(V325050)	1	U.V
..	..	REAR PANEL ASSEMBLY	(V329690)	1	H
..	..	REAR PANEL ASSEMBLY	(V329070)	1	B
..	..	REAR PANEL ASSEMBLY	(V329070)	1	B
10	V3281700	REAR PANEL	(V288430) (V333800)	21	01
..	..	REAR PANEL	(V288450) (V337800)	01	01
10	V3281800	REAR PANEL		05	05
10	V3281900	REAR PANEL		06	06
20	AA300140	CIRCUIT BOARD		1	U.V
20	AA300140	CIRCUIT BOARD		1	H.W.B
30	VN413300	BRANDING TAPPING SCREW B		21	01
40	V3277000	AC CORD		05	05
50	VV206600	AC CORD		06	06
50	V3277100	AC CORD		08	08
50	VV058300	AC CORD		01	01
60	VV103100	COLD STRAIN RELIEF		01	01
70	VU851100	EXHAUSTION POWER SWITCH		02	02
80	VU859000	POWER SWITCH KNOB		01	01
90	XV179A00	POWER TRANSFORMER		1	J
90	XV180A00	POWER TRANSFORMER		1	U.V
90	XV181A00	POWER TRANSFORMER		1	H.W.B
100	VR138400	BRAND HEAD TAPPING SCREW B		4	01
110	EP600190	BRAND HEAD TAPPING SCREW B		1	01
120	VV900200	CORD DIMPERS		2	01

* New Parts

RAIK Japan only

REF NO.	PART NO.	DESCRIPTION		REMARKS	QTY	RANK
*	AAX00150	Circuit Board	JK12	(V288440,XV336B0) GF24/12(9-20ch), GF16/12(1-12ch)		
	VV291400	Jumper Wire	0.60			01
C101	UJ667470	Electrolytic Cap.	47.00 50.0V			01
C102	VV488800	Electrolytic Cap. LLM	10.00 50.0V			01
-109	VV488800	Electrolytic Cap. LLM	10.00 50.0V			01
C110	UJ667470	Electrolytic Cap.	47.00 50.0V			01
C111	VV488800	Electrolytic Cap. LLM	10.00 50.0V			01
-118	VV488800	Electrolytic Cap. LLM	10.00 50.0V			01
C119	UJ667470	Electrolytic Cap.	47.00 50.0V			01
C120	VV488800	Electrolytic Cap. LLM	10.00 50.0V			01
-127	VV488800	Electrolytic Cap. LLM	10.00 50.0V			01
C128	VZ353500	Ceramic Capacitor-SL	100P 50V J			01
-151	VZ353500	Ceramic Capacitor-SL	100P 50V J			01
CN101	VV067600	Connector Base Post	M2426XX 2P TE			01
* CN102	VQ046400	Connector, FFC	52044 35P SE			01
* -104	VQ046400	Connector, FFC	52044 35P SE			01
CN105	VV067600	Connector Base Post	M2426XX 2P TE			01
JK101	VU805200	XLM Connector	XLR NC3FAV1-0	INPUT A(GF24/12:9-12ch, GF16/12:1-4ch)		04
-104	VU805200	XLM Connector	XLR NC3FAV1-0	INPUT B, INSERT I/O 0dB (GF24/12:9-12ch, GF16/12:1-4ch)		04
JK105	V2886000	Phone Jack	JY-6351F-06-340	INPUT B, INSERT I/O 0dB (GF24/12:9-12ch, GF16/12:1-4ch)		02
-112	V2886000	Phone Jack	JY-6351F-06-340	INPUT A(GF24/12:13-16ch, GF16/12:5-8ch)		02
JK113	VU805200	XLM Connector	XLR NC3FAV1-0	INPUT B, INSERT I/O 0dB (GF24/12:13-16ch, GF16/12:5-8ch)		04
-116	VU805200	XLM Connector	XLR NC3FAV1-0	INPUT A(GF24-12:17-20ch, GF16/12:9-12ch)		04
JK117	V2886000	Phone Jack	JY-6351F-06-340	INPUT B, INSERT I/O 0dB (GF24/12:13-16ch, GF16/12:5-8ch)		02
-124	V2886000	Phone Jack	JY-6351F-06-340	INPUT A(GF24-12:17-20ch, GF16/12:9-12ch)		02
JK125	VU805200	XLM Connector	XLR NC3FAV1-0	INPUT B, INSERT I/O 0dB (GF24/12:17-20ch, GF16/12:9-12ch)		04
-128	VU805200	XLM Connector	XLR NC3FAV1-0	INPUT B, INSERT I/O 0dB (GF24/12:17-20ch, GF16/12:9-12ch)		04
JK129	V2886000	Phone Jack	JY-6351F-06-340	INPUT B, INSERT I/O 0dB (GF24/12:17-20ch, GF16/12:9-12ch)		02
-136	V2886000	Phone Jack	JY-6351F-06-340			02
R101	VV058400	Flame Proof C. Resistor	390.0 1/4 J			01
R102	HF454220	Carbon Resistor	22.0 1/4 J			01
R103	HF454220	Carbon Resistor	22.0 1/4 J			01
R104	HF455330	Carbon Resistor	330.0 1/4 J			01
R105	VV065300	Metal Film Resistor	6.8K 1/4 F			01
R106	VV065300	Metal Film Resistor	6.8K 1/4 F			01
R107	HF454220	Carbon Resistor	22.0 1/4 J			01
R108	HF454220	Carbon Resistor	22.0 1/4 J			01
R109	HF455330	Carbon Resistor	330.0 1/4 J			01
R110	VV065300	Metal Film Resistor	6.8K 1/4 F			01
R111	VV065300	Metal Film Resistor	6.8K 1/4 F			01
R112	HF454220	Carbon Resistor	22.0 1/4 J			01
R113	HF454220	Carbon Resistor	22.0 1/4 J			01
R114	HF455330	Carbon Resistor	330.0 1/4 J			01
R115	VV065300	Metal Film Resistor	6.8K 1/4 F			01
R116	VV065300	Metal Film Resistor	6.8K 1/4 F			01
R117	HF454220	Carbon Resistor	22.0 1/4 J			01
R118	HF454220	Carbon Resistor	22.0 1/4 J			01
R119	HF455330	Carbon Resistor	330.0 1/4 J			01
R120	VV065300	Metal Film Resistor	6.8K 1/4 F			01
R121	VV065300	Metal Film Resistor	6.8K 1/4 F			01
R122	VV058400	Flame Proof C. Resistor	390.0 1/4 J			01
R123	HF454220	Carbon Resistor	22.0 1/4 J			01
R124	HF454220	Carbon Resistor	22.0 1/4 J			01
R125	HF455330	Carbon Resistor	330.0 1/4 J			01
R126	VV065300	Metal Film Resistor	6.8K 1/4 F			01
R127	VV065300	Metal Film Resistor	6.8K 1/4 F			01
R128	HF454220	Carbon Resistor	22.0 1/4 J			01
R129	HF454220	Carbon Resistor	22.0 1/4 J			01
R130	HF455330	Carbon Resistor	330.0 1/4 J			01
R131	VV065300	Metal Film Resistor	6.8K 1/4 F			01
R132	VV065300	Metal Film Resistor	6.8K 1/4 F			01
R133	HF454220	Carbon Resistor	22.0 1/4 J			01
R134	HF454220	Carbon Resistor	22.0 1/4 J			01
R135	HF455330	Carbon Resistor	330.0 1/4 J			01

*: New Parts

RANK : Japan only

REF NO.	PART NO.	DESCRIPTION		REMARKS	QTY	RANK
R136	VV065300	Metal Film Resistor	6.8K 1/4 F			01
R137	VV065300	Metal Film Resistor	6.8K 1/4 F			01
R138	HF454220	Carbon Resistor	22.0 1/4 J			01
R139	HF454220	Carbon Resistor	22.0 1/4 J			01
R140	HF455330	Carbon Resistor	330.0 1/4 J			01
R141	VV065300	Metal Film Resistor	6.8K 1/4 F			01
R142	VV065300	Metal Film Resistor	6.8K 1/4 F			01
R143	VV058400	Flame Proof C. Resistor	390.0 1/4 J			01
R144	HF454220	Carbon Resistor	22.0 1/4 J			01
R145	HF454220	Carbon Resistor	22.0 1/4 J			01
R146	HF455330	Carbon Resistor	330.0 1/4 J			01
R147	VV065300	Metal Film Resistor	6.8K 1/4 F			01
R148	VV065300	Metal Film Resistor	6.8K 1/4 F			01
R149	HF454220	Carbon Resistor	22.0 1/4 J			01
R150	HF454220	Carbon Resistor	22.0 1/4 J			01
R151	HF455330	Carbon Resistor	330.0 1/4 J			01
R152	VV065300	Metal Film Resistor	6.8K 1/4 F			01
R153	VV065300	Metal Film Resistor	6.8K 1/4 F			01
R154	HF454220	Carbon Resistor	22.0 1/4 J			01
R155	HF454220	Carbon Resistor	22.0 1/4 J			01
R156	HF455330	Carbon Resistor	330.0 1/4 J			01
R157	VV065300	Metal Film Resistor	6.8K 1/4 F			01
R158	VV065300	Metal Film Resistor	6.8K 1/4 F			01
R159	HF454220	Carbon Resistor	22.0 1/4 J			01
R160	HF454220	Carbon Resistor	22.0 1/4 J			01
R161	HF455330	Carbon Resistor	330.0 1/4 J			01
R162	VV065300	Metal Film Resistor	6.8K 1/4 F			01
R163	VV065300	Metal Film Resistor	6.8K 1/4 F			01
*	AAX00160	Circuit Board	OUT	(V288450,XV337B0)		
CN101	VQ047500	Connector	52045 20P TE			01
CN102	VQ047500	Connector	52045 20P TE			01
CN103	VV067000	Connector Base Post	M2426XX 10P TE			01
CN104	VV066900	Connector Base Post	M2426XX 9P TE			01
CN105	VV066900	Connector Base Post	M2426XX 9P TE			01
JK101	V2886000	Phone Jack	JY-6351F-06-340	INPUT A(MONO)		02
-104	V2886000	Phone Jack	JY-6351F-06-340			02
JK105	VZ358700	Pin Connector	PIN JACKJK040057DN	INPUT B		02
JK106	V2886000	Phone Jack	JY-6351F-06-340	AUX RETURN +4dB(MONO)		02
-109	V2886000	Phone Jack	JY-6351F-06-340			02
JK110	VZ358700	Pin Connector	PIN JACKJK040057DN	TAPE IN, REC OUT(RL)		02
JK111	V2886000	Phone Jack	JY-6351F-06-340	AUX OUT, GROUP OUT, ST		02
-124	V2886000	Phone Jack	JY-6351F-06-340	INSERT I/O, C-R MONI OUT		02
* JK125	VU805200	XLM Connector	XLR NC3FAV1-0	MONO OUT, STEREO OUT(L,R)		04
* -127	VU805200	XLM Connector	XLR NC3FAV1-0			04
R101	HF456150	Carbon Resistor	1.5K 1/4 J			01
R102	HF456150	Carbon Resistor	1.5K 1/4 J			01
R103	HF456120	Carbon Resistor	1.2K 1/4 J			01
R104	HF456120	Carbon Resistor	1.2K 1/4 J			01
R105	HF454750	Carbon Resistor	75.0 1/4 J			01
-110	HF454750	Carbon Resistor	75.0 1/4 J			01
R111	HF455330	Carbon Resistor	330.0 1/4 J			01
R112	HF455330	Carbon Resistor	330.0 1/4 J			01
R113	HF457220	Carbon Resistor	22.0K 1/4 J			01
R114	HF457220	Carbon Resistor	22.0K 1/4 J			01
*	V2884000	Circuit Board	IN8	(XV332B0) GF24/12, GF12/12(1-8ch)		
*	V3297600	Earth Terminal				
	VV307300	Spacer, LED				01
	VZ968500	Button	NO.947 CD-GRAY			01
	VZ968600	Button	NO.947 CD-GRAY			01
	VZ968700	Button	NO.946 CL-GRAY			01
	V2947200	Button	MX-BLUE			01
C101	UM417100	Electrolytic Cap.	10.00 25.0V			01
C102	UM417100	Electrolytic Cap.	10.00 25.0V			01
C103	VZ353600	Ceramic Cap.-B	220P 50V K			01
C104	VZ353600	Ceramic Cap.-B	220P 50V K			01
C105	VZ353800	Ceramic Cap.-B	470P 50V K			01
C106	VZ352700	Ceramic Capacitor-SL	10P 50V J			01

* : New Parts

RANK : Japan only

REF NO.	PART NO.	DESCRIPTION		REMARKS	QTY	RANK
C107	VV330700	Electrolytic Cap.-SM	470.00 10.0V			01
C108	VZ353800	Ceramic Cap.-B	470P 50V K			01
C109	VZ352700	Ceramic Capacitor-SL	10P 50V J			01
C110	VZ353700	Ceramic Cap.-B	330P 50V K			01
C111	VZ353000	Ceramic Capacitor-SL	33P 50V J			01
C112	UM417100	Electrolytic Cap.	10.00 25.0V			01
C113	VZ597300	Mylar Capacitor	0.091 50V J			01
C114	VZ597300	Mylar Capacitor	0.091 50V J			01
C115	VZ353500	Ceramic Capacitor-SL	100P 50V J			01
C116	UM417100	Electrolytic Cap.	10.00 25.0V			01
C117	UM417100	Electrolytic Cap.	10.00 25.0V			01
C118	VV062300	Mylar Capacitor	0.039 50V J			01
C119	VV190000	Mylar Capacitor	820P 50V J			01
C120	VZ353200	Ceramic Capacitor-SL	47P 50V J			01
C121	VZ353500	Ceramic Capacitor-SL	100P 50V J			01
C122	VV060800	Mylar Capacitor	3900P 50V J			01
C123	VZ353500	Ceramic Capacitor-SL	100P 50V J			01
C124	VV061400	Mylar Capacitor	0.010 50V J			01
C125	VZ352800	Ceramic Capacitor-SL	22P 50V J			01
C126	UJ667470	Electrolytic Cap.	47.00 25.0V			01
C127	UM416470	Electrolytic Cap.	4.70 50.0V			01
C128	VV062400	Mylar Capacitor	0.047 50V J			01
C129	VZ354000	Ceramic Capacitor-F	0.0100 50V Z			01
C130	VZ354000	Ceramic Capacitor-F	0.0100 50V Z			01
C133	VZ354000	Ceramic Capacitor-F	0.0100 50V Z			01
C134	VZ354000	Ceramic Capacitor-F	0.0100 50V Z			01
C135	UM417100	Electrolytic Cap.	10.00 25.0V			01
C136	VZ353900	Ceramic Cap.-B	1000P 50V K			01
C137	VZ353500	Ceramic Capacitor-SL	100P 50V J			01
C138	VZ353500	Ceramic Capacitor-SL	100P 50V J			01
C139	VZ353200	Ceramic Capacitor-SL	47P 50V J			01
C140	UJ667470	Electrolytic Cap.	47.00 25.0V			01
C141	UM417100	Electrolytic Cap.	10.00 25.0V			01
C142	VZ353500	Ceramic Capacitor-SL	100P 50V J			01
C143	VZ353500	Ceramic Capacitor-SL	100P 50V J			01
C144	VZ353200	Ceramic Capacitor-SL	47P 50V J			01
C145	UJ667470	Electrolytic Cap.	47.00 25.0V			01
C201	UM417100	Electrolytic Cap.	10.00 25.0V			01
C202	UM417100	Electrolytic Cap.	10.00 25.0V			01
C203	VZ353600	Ceramic Cap.-B	220P 50V K			01
C204	VZ353600	Ceramic Cap.-B	220P 50V K			01
C205	VZ353800	Ceramic Cap.-B	470P 50V K			01
C206	VZ352700	Ceramic Capacitor-SL	10P 50V J			01
C207	VV330700	Electrolytic Cap.-SM	470.00 10.0V			01
C208	VZ353800	Ceramic Cap.-B	470P 50V K			01
C209	VZ352700	Ceramic Capacitor-SL	10P 50V J			01
C210	VZ353700	Ceramic Cap.-B	330P 50V K			01
C211	VZ353000	Ceramic Capacitor-SL	33P 50V J			01
C212	UM417100	Electrolytic Cap.	10.00 25.0V			01
C213	VZ597300	Mylar Capacitor	0.091 50V J			01
C214	VZ597300	Mylar Capacitor	0.091 50V J			01
C215	VZ353500	Ceramic Capacitor-SL	100P 50V J			01
C216	UM417100	Electrolytic Cap.	10.00 25.0V			01
C217	UM417100	Electrolytic Cap.	10.00 25.0V			01
C218	VV062300	Mylar Capacitor	0.039 50V J			01
C219	VV190000	Mylar Capacitor	820P 50V J			01
C220	VZ353200	Ceramic Capacitor-SL	47P 50V J			01
C221	VZ353500	Ceramic Capacitor-SL	100P 50V J			01
C222	VV060800	Mylar Capacitor	3900P 50V J			01
C223	VZ353500	Ceramic Capacitor-SL	100P 50V J			01
C224	VV061400	Mylar Capacitor	0.010 50V J			01
C225	VZ352800	Ceramic Capacitor-SL	22P 50V J			01
C226	UJ667470	Electrolytic Cap.	47.00 25.0V			01
C227	UM416470	Electrolytic Cap.	4.70 50.0V			01
C228	VV062400	Mylar Capacitor	0.047 50V J			01
C229	UM417100	Electrolytic Cap.	10.00 25.0V			01
C230	VZ353500	Ceramic Capacitor-SL	100P 50V J			01
C231	VZ353500	Ceramic Capacitor-SL	100P 50V J			01
C232	VZ353200	Ceramic Capacitor-SL	47P 50V J			01
C233	VZ354000	Ceramic Capacitor-F	0.0100 50V Z			01

*: New Parts

RANK : Japan only

REF NO.	PART NO.	DESCRIPTION		REMARKS	QTY	RANK
C234	VZ354000	Ceramic Capacitor-F	0.0100 50V Z			01
C235	UJ667470	Electrolytic Cap.	47.00 25.0V			01
C236	UM417100	Electrolytic Cap.	10.00 25.0V			01
C237	VZ353500	Ceramic Capacitor-SL	100P 50V J			01
C238	VZ353500	Ceramic Capacitor-SL	100P 50V J			01
C239	VZ353200	Ceramic Capacitor-SL	47P 50V J			01
C240	VZ354000	Ceramic Capacitor-F	0.0100 50V Z			01
C241	VZ354000	Ceramic Capacitor-F	0.0100 50V Z			01
C242	UJ667470	Electrolytic Cap.	47.00 25.0V			01
C301	UM417100	Electrolytic Cap.	10.00 25.0V			01
C302	UM417100	Electrolytic Cap.	10.00 25.0V			01
C303	VZ353600	Ceramic Cap.-B	220P 50V K			01
C304	VZ353600	Ceramic Cap.-B	220P 50V K			01
C305	VZ353800	Ceramic Cap.-B	470P 50V K			01
C306	VZ352700	Ceramic Capacitor-SL	10P 50V J			01
C307	VV330700	Electrolytic Cap.-SM	470.00 10.0V			01
C308	VZ353800	Ceramic Cap.-B	470P 50V K			01
C309	VZ352700	Ceramic Capacitor-SL	10P 50V J			01
C310	VZ353700	Ceramic Cap.-B	330P 50V K			01
C311	VZ353000	Ceramic Capacitor-SL	33P 50V J			01
C312	UM417100	Electrolytic Cap.	10.00 25.0V			01
C313	VZ597300	Mylar Capacitor	0.091 50V J			01
C314	VZ597300	Mylar Capacitor	0.091 50V J			01
C315	VZ353500	Ceramic Capacitor-SL	100P 50V J			01
C316	UM417100	Electrolytic Cap.	10.00 25.0V			01
C317	UM417100	Electrolytic Cap.	10.00 25.0V			01
C318	VV062300	Mylar Capacitor	0.039 50V J			01
C319	VV190000	Mylar Capacitor	820P 50V J			01
C320	VZ353200	Ceramic Capacitor-SL	47P 50V J			01
C321	VZ353500	Ceramic Capacitor-SL	100P 50V J			01
C322	VV060800	Mylar Capacitor	3900P 50V J			01
C323	VZ353500	Ceramic Capacitor-SL	100P 50V J			01
C324	VV061400	Mylar Capacitor	0.010 50V J			01
C325	VZ352800	Ceramic Capacitor-SL	22P 50V J			01
C326	UJ667470	Electrolytic Cap.	47.00 25.0V			01
C327	UM416470	Electrolytic Cap.	4.70 50.0V			01
C328	VV062400	Mylar Capacitor	0.047 50V J			01
C329	VZ354000	Ceramic Capacitor-F	0.0100 50V Z			01
C330	VZ354000	Ceramic Capacitor-F	0.0100 50V Z			01
C333	VZ354000	Ceramic Capacitor-F	0.0100 50V Z			01
C334	VZ354000	Ceramic Capacitor-F	0.0100 50V Z			01
C335	UM417100	Electrolytic Cap.	10.00 25.0V			01
C336	VZ353900	Ceramic Cap.-B	1000P 50V K			01
C337	VZ353500	Ceramic Capacitor-SL	100P 50V J			01
C338	VZ353500	Ceramic Capacitor-SL	100P 50V J			01
C339	VZ353200	Ceramic Capacitor-SL	47P 50V J			01
C340	UJ667470	Electrolytic Cap.	47.00 25.0V			01
C341	UM417100	Electrolytic Cap.	10.00 25.0V			01
C342	VZ353500	Ceramic Capacitor-SL	100P 50V J			01
C343	VZ353500	Ceramic Capacitor-SL	100P 50V J			01
C344	VZ353200	Ceramic Capacitor-SL	47P 50V J			01
C345	UJ667470	Electrolytic Cap.	47.00 25.0V			01
C401	UM417100	Electrolytic Cap.	10.00 25.0V			01
C402	UM417100	Electrolytic Cap.	10.00 25.0V			01
C403	VZ353600	Ceramic Cap.-B	220P 50V K			01
C404	VZ353600	Ceramic Cap.-B	220P 50V K			01
C405	VZ353800	Ceramic Cap.-B	470P 50V K			01
C406	VZ352700	Ceramic Capacitor-SL	10P 50V J			01
C407	VV330700	Electrolytic Cap.-SM	470.00 10.0V			01
C408	VZ353800	Ceramic Cap.-B	470P 50V K			01
C409	VZ352700	Ceramic Capacitor-SL	10P 50V J			01
C410	VZ353700	Ceramic Cap.-B	330P 50V K			01
C411	VZ353000	Ceramic Capacitor-SL	33P 50V J			01
C412	UM417100	Electrolytic Cap.	10.00 25.0V			01
C413	VZ597300	Mylar Capacitor	0.091 50V J			01
C414	VZ597300	Mylar Capacitor	0.091 50V J			01
C415	VZ353500	Ceramic Capacitor-SL	100P 50V J			01
C416	UM417100	Electrolytic Cap.	10.00 25.0V			01
C417	UM417100	Electrolytic Cap.	10.00 25.0V			01
C418	VV062300	Mylar Capacitor	0.039 50V J			01

* : New Parts

RANK : Japan only

REF NO.	PART NO.	DESCRIPTION		REMARKS	QTY	RANK
C419	VV190000	Mylar Capacitor	820P 50V J			01
C420	VZ353200	Ceramic Capacitor-SL	47P 50V J			01
C421	VZ353500	Ceramic Capacitor-SL	100P 50V J			01
C422	VV060800	Mylar Capacitor	3900P 50V J			01
C423	VZ353500	Ceramic Capacitor-SL	100P 50V J			01
C424	VV061400	Mylar Capacitor	0.010 50V J			01
C425	VZ352800	Ceramic Capacitor-SL	22P 50V J			01
C426	UJ667470	Electrolytic Cap.	47.00 25.0V			01
C427	UM416470	Electrolytic Cap.	4.70 50.0V			01
C428	VV062400	Mylar Capacitor	0.047 50V J			01
C429	UM417100	Electrolytic Cap.	10.00 25.0V			01
C430	VZ353500	Ceramic Capacitor-SL	100P 50V J			01
C431	VZ353500	Ceramic Capacitor-SL	100P 50V J			01
C432	VZ353200	Ceramic Capacitor-SL	47P 50V J			01
C433	VZ354000	Ceramic Capacitor-F	0.0100 50V Z			01
C434	VZ354000	Ceramic Capacitor-F	0.0100 50V Z			01
C435	UJ667470	Electrolytic Cap.	47.00 25.0V			01
C436	UM417100	Electrolytic Cap.	10.00 25.0V			01
C437	VZ353500	Ceramic Capacitor-SL	100P 50V J			01
C438	VZ353500	Ceramic Capacitor-SL	100P 50V J			01
C439	VZ353200	Ceramic Capacitor-SL	47P 50V J			01
C440	VZ354000	Ceramic Capacitor-F	0.0100 50V Z			01
C441	VZ354000	Ceramic Capacitor-F	0.0100 50V Z			01
C442	UJ667470	Electrolytic Cap.	47.00 25.0V			01
C501	UM417100	Electrolytic Cap.	10.00 25.0V			01
C502	UM417100	Electrolytic Cap.	10.00 25.0V			01
C503	VZ353600	Ceramic Cap.-B	220P 50V K			01
C504	VZ353600	Ceramic Cap.-B	220P 50V K			01
C505	VZ353800	Ceramic Cap.-B	470P 50V K			01
C506	VZ352700	Ceramic Capacitor-SL	10P 50V J			01
C507	VV330700	Electrolytic Cap.-SM	470.00 10.0V			01
C508	VZ353800	Ceramic Cap.-B	470P 50V K			01
C509	VZ352700	Ceramic Capacitor-SL	10P 50V J			01
C510	VZ353700	Ceramic Cap.-B	330P 50V K			01
C511	VZ353000	Ceramic Capacitor-SL	33P 50V J			01
C512	UM417100	Electrolytic Cap.	10.00 25.0V			01
C513	VZ597300	Mylar Capacitor	0.091 50V J			01
C514	VZ597300	Mylar Capacitor	0.091 50V J			01
C515	VZ353500	Ceramic Capacitor-SL	100P 50V J			01
C516	UM417100	Electrolytic Cap.	10.00 25.0V			01
C517	UM417100	Electrolytic Cap.	10.00 25.0V			01
C518	VV062300	Mylar Capacitor	0.039 50V J			01
C519	VV190000	Mylar Capacitor	820P 50V J			01
C520	VZ353200	Ceramic Capacitor-SL	47P 50V J			01
C521	VZ353500	Ceramic Capacitor-SL	100P 50V J			01
C522	VV060800	Mylar Capacitor	3900P 50V J			01
C523	VZ353500	Ceramic Capacitor-SL	100P 50V J			01
C524	VV061400	Mylar Capacitor	0.010 50V J			01
C525	VZ352800	Ceramic Capacitor-SL	22P 50V J			01
C526	UJ667470	Electrolytic Cap.	47.00 25.0V			01
C527	UM416470	Electrolytic Cap.	4.70 50.0V			01
C528	VV062400	Mylar Capacitor	0.047 50V J			01
C529	VZ354000	Ceramic Capacitor-F	0.0100 50V Z			01
C530	VZ354000	Ceramic Capacitor-F	0.0100 50V Z			01
C533	VZ354000	Ceramic Capacitor-F	0.0100 50V Z			01
C534	VZ354000	Ceramic Capacitor-F	0.0100 50V Z			01
C535	UM417100	Electrolytic Cap.	10.00 25.0V			01
C536	VZ353900	Ceramic Cap.-B	1000P 50V K			01
C537	VZ353500	Ceramic Capacitor-SL	100P 50V J			01
C538	VZ353500	Ceramic Capacitor-SL	100P 50V J			01
C539	VZ353200	Ceramic Capacitor-SL	47P 50V J			01
C540	UJ667470	Electrolytic Cap.	47.00 25.0V			01
C541	UM417100	Electrolytic Cap.	10.00 25.0V			01
C542	VZ353500	Ceramic Capacitor-SL	100P 50V J			01
C543	VZ353500	Ceramic Capacitor-SL	100P 50V J			01
C544	VZ353200	Ceramic Capacitor-SL	47P 50V J			01
C545	UJ667470	Electrolytic Cap.	47.00 25.0V			01
C601	UM417100	Electrolytic Cap.	10.00 25.0V			01
C602	UM417100	Electrolytic Cap.	10.00 25.0V			01
C603	VZ353600	Ceramic Cap.-B	220P 50V K			01

*: New Parts

RANK : Japan only

GF24/12
GF16/12
GF12/12

REF NO.	PART NO.	DESCRIPTION		REMARKS	QTY	RANK
C604	VZ353600	Ceramic Cap.-B	220P 50V K			01
C605	VZ353800	Ceramic Cap.-B	470P 50V K			01
C606	VZ352700	Ceramic Capacitor-SL	10P 50V J			01
C607	VV330700	Electrolytic Cap.-SM	470.00 10.0V			01
C608	VZ353800	Ceramic Cap.-B	470P 50V K			01
C609	VZ352700	Ceramic Capacitor-SL	10P 50V J			01
C610	VZ353700	Ceramic Cap.-B	330P 50V K			01
C611	VZ353000	Ceramic Capacitor-SL	33P 50V J			01
C612	UM417100	Electrolytic Cap.	10.00 25.0V			01
C613	VZ597300	Mylar Capacitor	0.091 50V J			01
C614	VZ597300	Mylar Capacitor	0.091 50V J			01
C615	VZ353500	Ceramic Capacitor-SL	100P 50V J			01
C616	UM417100	Electrolytic Cap.	10.00 25.0V			01
C617	UM417100	Electrolytic Cap.	10.00 25.0V			01
C618	VV062300	Mylar Capacitor	0.039 50V J			01
C619	VV190000	Mylar Capacitor	820P 50V J			01
C620	VZ353200	Ceramic Capacitor-SL	47P 50V J			01
C621	VZ353500	Ceramic Capacitor-SL	100P 50V J			01
C622	VV060800	Mylar Capacitor	3900P 50V J			01
C623	VZ353500	Ceramic Capacitor-SL	100P 50V J			01
C624	VV061400	Mylar Capacitor	0.010 50V J			01
C625	VZ352800	Ceramic Capacitor-SL	22P 50V J			01
C626	UJ667470	Electrolytic Cap.	47.00 25.0V			01
C627	UM416470	Electrolytic Cap.	4.70 50.0V			01
C628	VV062400	Mylar Capacitor	0.047 50V J			01
C629	UM417100	Electrolytic Cap.	10.00 25.0V			01
C630	VZ353500	Ceramic Capacitor-SL	100P 50V J			01
C631	VZ353500	Ceramic Capacitor-SL	100P 50V J			01
C632	VZ353200	Ceramic Capacitor-SL	47P 50V J			01
C633	VZ354000	Ceramic Capacitor-F	0.0100 50V Z			01
C634	VZ354000	Ceramic Capacitor-F	0.0100 50V Z			01
C635	UJ667470	Electrolytic Cap.	47.00 25.0V			01
C636	UM417100	Electrolytic Cap.	10.00 25.0V			01
C637	VZ353500	Ceramic Capacitor-SL	100P 50V J			01
C638	VZ353500	Ceramic Capacitor-SL	100P 50V J			01
C639	VZ353200	Ceramic Capacitor-SL	47P 50V J			01
C640	VZ354000	Ceramic Capacitor-F	0.0100 50V Z			01
C641	VZ354000	Ceramic Capacitor-F	0.0100 50V Z			01
C642	UJ667470	Electrolytic Cap.	47.00 25.0V			01
C701	UM417100	Electrolytic Cap.	10.00 25.0V			01
C702	UM417100	Electrolytic Cap.	10.00 25.0V			01
C703	VZ353600	Ceramic Cap.-B	220P 50V K			01
C704	VZ353600	Ceramic Cap.-B	220P 50V K			01
C705	VZ353800	Ceramic Cap.-B	470P 50V K			01
C706	VZ352700	Ceramic Capacitor-SL	10P 50V J			01
C707	VV330700	Electrolytic Cap.-SM	470.00 10.0V			01
C708	VZ353800	Ceramic Cap.-B	470P 50V K			01
C709	VZ352700	Ceramic Capacitor-SL	10P 50V J			01
C710	VZ353700	Ceramic Cap.-B	330P 50V K			01
C711	VZ353000	Ceramic Capacitor-SL	33P 50V J			01
C712	UM417100	Electrolytic Cap.	10.00 25.0V			01
C713	VZ597300	Mylar Capacitor	0.091 50V J			01
C714	VZ597300	Mylar Capacitor	0.091 50V J			01
C715	VZ353500	Ceramic Capacitor-SL	100P 50V J			01
C716	UM417100	Electrolytic Cap.	10.00 25.0V			01
C717	UM417100	Electrolytic Cap.	10.00 25.0V			01
C718	VV062300	Mylar Capacitor	0.039 50V J			01
C719	VV190000	Mylar Capacitor	820P 50V J			01
C720	VZ353200	Ceramic Capacitor-SL	47P 50V J			01
C721	VZ353500	Ceramic Capacitor-SL	100P 50V J			01
C722	VV060800	Mylar Capacitor	3900P 50V J			01
C723	VZ353500	Ceramic Capacitor-SL	100P 50V J			01
C724	VV061400	Mylar Capacitor	0.010 50V J			01
C725	VZ352800	Ceramic Capacitor-SL	22P 50V J			01
C726	UJ667470	Electrolytic Cap.	47.00 25.0V			01
C727	UM416470	Electrolytic Cap.	4.70 50.0V			01
C728	VV062400	Mylar Capacitor	0.047 50V J			01
C729	VZ354000	Ceramic Capacitor-F	0.0100 50V Z			01
C730	VZ354000	Ceramic Capacitor-F	0.0100 50V Z			01
C733	VZ354000	Ceramic Capacitor-F	0.0100 50V Z			01

* : New Parts

RANK : Japan only

REF NO.	PART NO.	DESCRIPTION		REMARKS	QTY	RANK
C734	VZ354000	Ceramic Capacitor-F	0.0100 50V Z			01
C735	UM417100	Electrolytic Cap.	10.00 25.0V			01
C736	VZ353900	Ceramic Cap.-B	1000P 50V K			01
C737	VZ353500	Ceramic Capacitor-SL	100P 50V J			01
C738	VZ353500	Ceramic Capacitor-SL	100P 50V J			01
C739	VZ353200	Ceramic Capacitor-SL	47P 50V J			01
C740	UJ667470	Electrolytic Cap.	47.00 25.0V			01
C741	UM417100	Electrolytic Cap.	10.00 25.0V			01
C742	VZ353500	Ceramic Capacitor-SL	100P 50V J			01
C743	VZ353500	Ceramic Capacitor-SL	100P 50V J			01
C744	VZ353200	Ceramic Capacitor-SL	47P 50V J			01
C745	UJ667470	Electrolytic Cap.	47.00 25.0V			01
C801	UM417100	Electrolytic Cap.	10.00 25.0V			01
C802	UM417100	Electrolytic Cap.	10.00 25.0V			01
C803	VZ353600	Ceramic Cap.-B	220P 50V K			01
C804	VZ353600	Ceramic Cap.-B	220P 50V K			01
C805	VZ353800	Ceramic Cap.-B	470P 50V K			01
C806	VZ352700	Ceramic Capacitor-SL	10P 50V J			01
C807	VV330700	Electrolytic Cap.-SM	470.00 10.0V			01
C808	VZ353800	Ceramic Cap.-B	470P 50V K			01
C809	VZ352700	Ceramic Capacitor-SL	10P 50V J			01
C810	VZ353700	Ceramic Cap.-B	330P 50V K			01
C811	VZ353000	Ceramic Capacitor-SL	33P 50V J			01
C812	UM417100	Electrolytic Cap.	10.00 25.0V			01
C813	VZ597300	Mylar Capacitor	0.091 50V J			01
C814	VZ597300	Mylar Capacitor	0.091 50V J			01
C815	VZ353500	Ceramic Capacitor-SL	100P 50V J			01
C816	UM417100	Electrolytic Cap.	10.00 25.0V			01
C817	UM417100	Electrolytic Cap.	10.00 25.0V			01
C818	VV062300	Mylar Capacitor	0.039 50V J			01
C819	VV190000	Mylar Capacitor	820P 50V J			01
C820	VZ353200	Ceramic Capacitor-SL	47P 50V J			01
C821	VZ353500	Ceramic Capacitor-SL	100P 50V J			01
C822	VV060800	Mylar Capacitor	3900P 50V J			01
C823	VZ353500	Ceramic Capacitor-SL	100P 50V J			01
C824	VV061400	Mylar Capacitor	0.010 50V J			01
C825	VZ352800	Ceramic Capacitor-SL	22P 50V J			01
C826	UJ667470	Electrolytic Cap.	47.00 25.0V			01
C827	UM416470	Electrolytic Cap.	4.70 50.0V			01
C828	VV062400	Mylar Capacitor	0.047 50V J			01
C829	UM417100	Electrolytic Cap.	10.00 25.0V			01
C830	VZ353500	Ceramic Capacitor-SL	100P 50V J			01
C831	VZ353500	Ceramic Capacitor-SL	100P 50V J			01
C832	VZ353200	Ceramic Capacitor-SL	47P 50V J			01
C833	VZ354000	Ceramic Capacitor-F	0.0100 50V Z			01
C834	VZ354000	Ceramic Capacitor-F	0.0100 50V Z			01
C835	UJ667470	Electrolytic Cap.	47.00 25.0V			01
C836	UM417100	Electrolytic Cap.	10.00 25.0V			01
C837	VZ353500	Ceramic Capacitor-SL	100P 50V J			01
C838	VZ353500	Ceramic Capacitor-SL	100P 50V J			01
C839	VZ353200	Ceramic Capacitor-SL	47P 50V J			01
C840	VZ354000	Ceramic Capacitor-F	0.0100 50V Z			01
C841	VZ354000	Ceramic Capacitor-F	0.0100 50V Z			01
C842	UJ667470	Electrolytic Cap.	47.00 25.0V			01
* CN101	V3456200	Connector	5597-NCPB 35P TE			
* CN102	V3456200	Connector	5597-NCPB 35P TE			
CN105	VV067200	Connector Base Post	M2426XX 12P TE			01
CN106	VV066700	Connector Base Post	M2426XX 7P TE			01
IC101	XF195A00	IC	NJM4580L	OP AMP		04
IC102	XF195A00	IC	NJM4580L	OP AMP		04
IC103	XM356A00	IC	NJM2068L-D	OP AMP		02
-105	XM356A00	IC	NJM2068L-D	OP AMP		02
IC106	XF195A00	IC	NJM4580L	OP AMP		04
IC107	XF195A00	IC	NJM4580L	OP AMP		04
IC108	XM356A00	IC	NJM2068L-D	OP AMP		02
-110	XM356A00	IC	NJM2068L-D	OP AMP		02
IC111	XF195A00	IC	NJM4580L	OP AMP		04
IC112	XF195A00	IC	NJM4580L	OP AMP		04
IC113	XM356A00	IC	NJM2068L-D	OP AMP		02
-115	XM356A00	IC	NJM2068L-D	OP AMP		02

*: New Parts

RANK : Japan only

REF NO.	PART NO.	DESCRIPTION		REMARKS	QTY	RANK
IC116	XF195A00	IC	NJM4580L	OP AMP		04
IC117	XF195A00	IC	NJM4580L	OP AMP		04
IC118	XM356A00	IC	NJM2068L-D	OP AMP		02
-128	XM356A00	IC	NJM2068L-D	OP AMP		02
LD101	VV620800	LED	LT311G-41-C13 RE	PEAK(1ch)		01
LD201	VV620800	LED	LT311G-41-C13 RE	PEAK(2ch)		01
LD301	VV620800	LED	LT311G-41-C13 RE	PEAK(3ch)		01
LD401	VV620800	LED	LT311G-41-C13 RE	PEAK(4ch)		01
LD501	VV620800	LED	LT311G-41-C13 RE	PEAK(5ch)		01
LD601	VV620800	LED	LT311G-41-C13 RE	PEAK(6ch)		01
LD701	VV620800	LED	LT311G-41-C13 RE	PEAK(7ch)		01
LD801	VV620800	LED	LT311G-41-C13 RE	PEAK(8ch)		01
Q101	IC224030	Transistor	2SC2240 GR,BL			01
Q102	IC224030	Transistor	2SC2240 GR,BL			01
Q103	IA101590	Transistor	2SA1015 O,Y			01
Q104	IC1815M0	Transistor	2SC1815 Y,GR			01
Q201	IC224030	Transistor	2SC2240 GR,BL			01
Q202	IC224030	Transistor	2SC2240 GR,BL			01
Q203	IA101590	Transistor	2SA1015 O,Y			01
Q204	IC1815M0	Transistor	2SC1815 Y,GR			01
Q301	IC224030	Transistor	2SC2240 GR,BL			01
Q302	IC224030	Transistor	2SC2240 GR,BL			01
Q303	IA101590	Transistor	2SA1015 O,Y			01
Q304	IC1815M0	Transistor	2SC1815 Y,GR			01
Q401	IC224030	Transistor	2SC2240 GR,BL			01
Q402	IC224030	Transistor	2SC2240 GR,BL			01
Q403	IA101590	Transistor	2SA1015 O,Y			01
Q404	IC1815M0	Transistor	2SC1815 Y,GR			01
Q501	IC224030	Transistor	2SC2240 GR,BL			01
Q502	IC224030	Transistor	2SC2240 GR,BL			01
Q503	IA101590	Transistor	2SA1015 O,Y			01
Q504	IC1815M0	Transistor	2SC1815 Y,GR			01
Q601	IC224030	Transistor	2SC2240 GR,BL			01
Q602	IC224030	Transistor	2SC2240 GR,BL			01
Q603	IA101590	Transistor	2SA1015 O,Y			01
Q604	IC1815M0	Transistor	2SC1815 Y,GR			01
Q701	IC224030	Transistor	2SC2240 GR,BL			01
Q702	IC224030	Transistor	2SC2240 GR,BL			01
Q703	IA101590	Transistor	2SA1015 O,Y			01
Q704	IC1815M0	Transistor	2SC1815 Y,GR			01
Q801	IC224030	Transistor	2SC2240 GR,BL			01
Q802	IC224030	Transistor	2SC2240 GR,BL			01
Q803	IA101590	Transistor	2SA1015 O,Y			01
Q804	IC1815M0	Transistor	2SC1815 Y,GR			01
R101	VV065200	Metal Film Resistor	4.7K 1/4 F			05
R102	VZ598300	Metal Film Resistor	510.0 1/4 F			01
R103	VV065200	Metal Film Resistor	4.7K 1/4 F			05
-105	VV065200	Metal Film Resistor	4.7K 1/4 F			05
R106	HF454100	Carbon Resistor	10.0 1/4 J			01
R107	HF454100	Carbon Resistor	10.0 1/4 J			01
R108	VV066100	Metal Film Resistor	47K 1/4 F			01
R109	VV066100	Metal Film Resistor	47K 1/4 F			01
R110	HF454100	Carbon Resistor	10.0 1/4 J			01
R111	VV065100	Metal Film Resistor	2.2K 1/4 F			01
R112	VV065400	Metal Film Resistor	8.2K 1/4 F			01
R113	VV064900	Metal Film Resistor	20.0 1/4 F			01
R114	VV065900	Metal Film Resistor	24K 1/4 F			01
R115	VV065100	Metal Film Resistor	2.2K 1/4 F			01
R116	VV065400	Metal Film Resistor	8.2K 1/4 F			01
R117	VV065900	Metal Film Resistor	24K 1/4 F			01
R118	HF454100	Carbon Resistor	10.0 1/4 J			01
R119	VV065200	Metal Film Resistor	4.7K 1/4 F			05
R120	VV065200	Metal Film Resistor	4.7K 1/4 F			05
R121	HF458220	Carbon Resistor	220.0K 1/4 J			01
R122	HF457150	Carbon Resistor	15.0K 1/4 J			01
R123	HF457300	Carbon Resistor	30.0K 1/4 J			01
R124	HF454100	Carbon Resistor	10.0 1/4 J			01
R125	HF458220	Carbon Resistor	220.0K 1/4 J			01
R126	HF458220	Carbon Resistor	220.0K 1/4 J			01
R127	HF457100	Carbon Resistor	10.0K 1/4 J			01

* : New Parts

RANK : Japan only

REF NO.	PART NO.	DESCRIPTION	REMARKS	QTY	RANK
R128	HF456470	Carbon Resistor	4.7K 1/4 J		01
R129	HF457330	Carbon Resistor	33.0K 1/4 J		01
R130	HF457100	Carbon Resistor	10.0K 1/4 J		01
R131	HF856560	Carbon Resistor	5.6K 1/4 J		01
R132	HF456470	Carbon Resistor	4.7K 1/4 J		01
R133	HF456820	Carbon Resistor	8.2K 1/4 J		01
R134	HF456470	Carbon Resistor	4.7K 1/4 J		01
R135	HF456820	Carbon Resistor	8.2K 1/4 J		01
R136	HF454100	Carbon Resistor	10.0 1/4 J		01
R137	HF458220	Carbon Resistor	220.0K 1/4 J		01
R138	HF858100	Carbon Resistor	100.0K 1/4 J		01
R139	HF456820	Carbon Resistor	8.2K 1/4 J		01
R140	HF858100	Carbon Resistor	100.0K 1/4 J		01
R141	HF456470	Carbon Resistor	4.7K 1/4 J		01
R142	HF858100	Carbon Resistor	100.0K 1/4 J		01
R143	HF456330	Carbon Resistor	3.3K 1/4 J		01
R144	HF456510	Carbon Resistor	5.1K 1/4 J		01
R145	HF456510	Carbon Resistor	5.1K 1/4 J		01
R146	HF454220	Carbon Resistor	22.0 1/4 J		01
R147	HF456510	Carbon Resistor	5.1K 1/4 J		01
R148	HF456510	Carbon Resistor	5.1K 1/4 J		01
R149	HF454220	Carbon Resistor	22.0 1/4 J		01
R150	HF455220	Carbon Resistor	220.0 1/4 J		01
R151	HF455220	Carbon Resistor	220.0 1/4 J		01
R152	HF456470	Carbon Resistor	4.7K 1/4 J		01
R153	HF457100	Carbon Resistor	10.0K 1/4 J		01
R154	HF454100	Carbon Resistor	10.0 1/4 J		01
R155	HF458220	Carbon Resistor	220.0K 1/4 J		01
R156	HF457180	Carbon Resistor	18.0K 1/4 J		01
-170	HF457180	Carbon Resistor	18.0K 1/4 J		01
R201	VV065200	Metal Film Resistor	4.7K 1/4 F		05
R202	VZ598300	Metal Film Resistor	510.0 1/4 F		01
R203	VV065200	Metal Film Resistor	4.7K 1/4 F		05
R204	VV065200	Metal Film Resistor	4.7K 1/4 F		05
R205	VV065200	Metal Film Resistor	4.7K 1/4 F		05
R206	HF454100	Carbon Resistor	10.0 1/4 J		01
R207	HF454100	Carbon Resistor	10.0 1/4 J		01
R208	VV066100	Metal Film Resistor	47K 1/4 F		01
R209	VV066100	Metal Film Resistor	47K 1/4 F		01
R210	HF454100	Carbon Resistor	10.0 1/4 J		01
R211	VV065100	Metal Film Resistor	2.2K 1/4 F		01
R212	VV065400	Metal Film Resistor	8.2K 1/4 F		01
R213	VV064900	Metal Film Resistor	20.0 1/4 F		01
R214	VV065900	Metal Film Resistor	24K 1/4 F		01
R215	VV065100	Metal Film Resistor	2.2K 1/4 F		01
R216	VV065400	Metal Film Resistor	8.2K 1/4 F		01
R217	VV065900	Metal Film Resistor	24K 1/4 F		01
R218	HF454100	Carbon Resistor	10.0 1/4 J		01
R219	VV065200	Metal Film Resistor	4.7K 1/4 F		05
R220	VV065200	Metal Film Resistor	4.7K 1/4 F		05
R221	HF458220	Carbon Resistor	220.0K 1/4 J		01
R222	HF457150	Carbon Resistor	15.0K 1/4 J		01
R223	HF457300	Carbon Resistor	30.0K 1/4 J		01
R224	HF454100	Carbon Resistor	10.0 1/4 J		01
R225	HF458220	Carbon Resistor	220.0K 1/4 J		01
R226	HF458220	Carbon Resistor	220.0K 1/4 J		01
R227	HF457100	Carbon Resistor	10.0K 1/4 J		01
R228	HF456470	Carbon Resistor	4.7K 1/4 J		01
R229	HF457330	Carbon Resistor	33.0K 1/4 J		01
R230	HF457100	Carbon Resistor	10.0K 1/4 J		01
R231	HF856560	Carbon Resistor	5.6K 1/4 J		01
R232	HF456470	Carbon Resistor	4.7K 1/4 J		01
R233	HF456820	Carbon Resistor	8.2K 1/4 J		01
R234	HF456470	Carbon Resistor	4.7K 1/4 J		01
R235	HF456820	Carbon Resistor	8.2K 1/4 J		01
R236	HF454100	Carbon Resistor	10.0 1/4 J		01
R237	HF458220	Carbon Resistor	220.0K 1/4 J		01
R238	HF858100	Carbon Resistor	100.0K 1/4 J		01
R239	HF456820	Carbon Resistor	8.2K 1/4 J		01
R240	HF858100	Carbon Resistor	100.0K 1/4 J		01

*: New Parts

RANK : Japan only

GF24/12
GF16/12
GF12/12

REF NO.	PART NO.	DESCRIPTION		REMARKS	QTY	RANK
R241	HF456470	Carbon Resistor	4.7K 1/4 J			01
R242	HF858100	Carbon Resistor	100.0K 1/4 J			01
R243	HF456330	Carbon Resistor	3.3K 1/4 J			01
R244	HF456510	Carbon Resistor	5.1K 1/4 J			01
R245	HF456510	Carbon Resistor	5.1K 1/4 J			01
R246	HF454220	Carbon Resistor	22.0 1/4 J			01
R247	HF456510	Carbon Resistor	5.1K 1/4 J			01
R248	HF456510	Carbon Resistor	5.1K 1/4 J			01
R249	HF454220	Carbon Resistor	22.0 1/4 J			01
R250	HF455220	Carbon Resistor	220.0 1/4 J			01
R251	HF455220	Carbon Resistor	220.0 1/4 J			01
R252	HF456470	Carbon Resistor	4.7K 1/4 J			01
R253	HF457100	Carbon Resistor	10.0K 1/4 J			01
R254	HF454100	Carbon Resistor	10.0 1/4 J			01
R255	HF458220	Carbon Resistor	220.0K 1/4 J			01
R256	HF457180	Carbon Resistor	18.0K 1/4 J			01
-270	HF457180	Carbon Resistor	18.0K 1/4 J			01
R301	VV065200	Metal Film Resistor	4.7K 1/4 F			05
R302	VZ598300	Metal Film Resistor	510.0 1/4 F			01
R303	VV065200	Metal Film Resistor	4.7K 1/4 F			05
-305	VV065200	Metal Film Resistor	4.7K 1/4 F			05
R306	HF454100	Carbon Resistor	10.0 1/4 J			01
R307	HF454100	Carbon Resistor	10.0 1/4 J			01
R308	VV066100	Metal Film Resistor	47K 1/4 F			01
R309	VV066100	Metal Film Resistor	47K 1/4 F			01
R310	HF454100	Carbon Resistor	10.0 1/4 J			01
R311	VV065100	Metal Film Resistor	2.2K 1/4 F			01
R312	VV065400	Metal Film Resistor	8.2K 1/4 F			01
R313	VV064900	Metal Film Resistor	20.0 1/4 F			01
R314	VV065900	Metal Film Resistor	24K 1/4 F			01
R315	VV065100	Metal Film Resistor	2.2K 1/4 F			01
R316	VV065400	Metal Film Resistor	8.2K 1/4 F			01
R317	VV065900	Metal Film Resistor	24K 1/4 F			01
R318	HF454100	Carbon Resistor	10.0 1/4 J			01
R319	VV065200	Metal Film Resistor	4.7K 1/4 F			05
R320	VV065200	Metal Film Resistor	4.7K 1/4 F			05
R321	HF458220	Carbon Resistor	220.0K 1/4 J			01
R322	HF457150	Carbon Resistor	15.0K 1/4 J			01
R323	HF457300	Carbon Resistor	30.0K 1/4 J			01
R324	HF454100	Carbon Resistor	10.0 1/4 J			01
R325	HF458220	Carbon Resistor	220.0K 1/4 J			01
R326	HF458220	Carbon Resistor	220.0K 1/4 J			01
R327	HF457100	Carbon Resistor	10.0K 1/4 J			01
R328	HF456470	Carbon Resistor	4.7K 1/4 J			01
R329	HF457330	Carbon Resistor	33.0K 1/4 J			01
R330	HF457100	Carbon Resistor	10.0K 1/4 J			01
R331	HF856560	Carbon Resistor	5.6K 1/4 J			01
R332	HF456470	Carbon Resistor	4.7K 1/4 J			01
R333	HF456820	Carbon Resistor	8.2K 1/4 J			01
R334	HF456470	Carbon Resistor	4.7K 1/4 J			01
R335	HF456820	Carbon Resistor	8.2K 1/4 J			01
R336	HF454100	Carbon Resistor	10.0 1/4 J			01
R337	HF458220	Carbon Resistor	220.0K 1/4 J			01
R338	HF858100	Carbon Resistor	100.0K 1/4 J			01
R339	HF456820	Carbon Resistor	8.2K 1/4 J			01
R340	HF858100	Carbon Resistor	100.0K 1/4 J			01
R341	HF456470	Carbon Resistor	4.7K 1/4 J			01
R342	HF858100	Carbon Resistor	100.0K 1/4 J			01
R343	HF456330	Carbon Resistor	3.3K 1/4 J			01
R344	HF456510	Carbon Resistor	5.1K 1/4 J			01
R345	HF456510	Carbon Resistor	5.1K 1/4 J			01
R346	HF454220	Carbon Resistor	22.0 1/4 J			01
R347	HF456510	Carbon Resistor	5.1K 1/4 J			01
R348	HF456510	Carbon Resistor	5.1K 1/4 J			01
R349	HF454220	Carbon Resistor	22.0 1/4 J			01
R350	HF455220	Carbon Resistor	220.0 1/4 J			01
R351	HF455220	Carbon Resistor	220.0 1/4 J			01
R352	HF456470	Carbon Resistor	4.7K 1/4 J			01
R353	HF457100	Carbon Resistor	10.0K 1/4 J			01
R354	HF454100	Carbon Resistor	10.0 1/4 J			01

* : New Parts

RANK : Japan only

REF NO.	PART NO.	DESCRIPTION	REMARKS	QTY	RANK
R355	HF458220	Carbon Resistor	220.0K 1/4 J		01
R356	HF457180	Carbon Resistor	18.0K 1/4 J		01
-370	HF457180	Carbon Resistor	18.0K 1/4 J		01
R401	VV065200	Metal Film Resistor	4.7K 1/4 F		05
R402	VZ598300	Metal Film Resistor	510.0 1/4 F		01
R403	VV065200	Metal Film Resistor	4.7K 1/4 F		05
R404	VV065200	Metal Film Resistor	4.7K 1/4 F		05
R405	VV065200	Metal Film Resistor	4.7K 1/4 F		05
R406	HF454100	Carbon Resistor	10.0 1/4 J		01
R407	HF454100	Carbon Resistor	10.0 1/4 J		01
R408	VV066100	Metal Film Resistor	47K 1/4 F		01
R409	VV066100	Metal Film Resistor	47K 1/4 F		01
R410	HF454100	Carbon Resistor	10.0 1/4 J		01
R411	VV065100	Metal Film Resistor	2.2K 1/4 F		01
R412	VV065400	Metal Film Resistor	8.2K 1/4 F		01
R413	VV064900	Metal Film Resistor	20.0 1/4 F		01
R414	VV065900	Metal Film Resistor	24K 1/4 F		01
R415	VV065100	Metal Film Resistor	2.2K 1/4 F		01
R416	VV065400	Metal Film Resistor	8.2K 1/4 F		01
R417	VV065900	Metal Film Resistor	24K 1/4 F		01
R418	HF454100	Carbon Resistor	10.0 1/4 J		01
R419	VV065200	Metal Film Resistor	4.7K 1/4 F		05
R420	VV065200	Metal Film Resistor	4.7K 1/4 F		05
R421	HF458220	Carbon Resistor	220.0K 1/4 J		01
R422	HF457150	Carbon Resistor	15.0K 1/4 J		01
R423	HF457300	Carbon Resistor	30.0K 1/4 J		01
R424	HF454100	Carbon Resistor	10.0 1/4 J		01
R425	HF458220	Carbon Resistor	220.0K 1/4 J		01
R426	HF458220	Carbon Resistor	220.0K 1/4 J		01
R427	HF457100	Carbon Resistor	10.0K 1/4 J		01
R428	HF456470	Carbon Resistor	4.7K 1/4 J		01
R429	HF457330	Carbon Resistor	33.0K 1/4 J		01
R430	HF457100	Carbon Resistor	10.0K 1/4 J		01
R431	HF856560	Carbon Resistor	5.6K 1/4 J		01
R432	HF456470	Carbon Resistor	4.7K 1/4 J		01
R433	HF456820	Carbon Resistor	8.2K 1/4 J		01
R434	HF456470	Carbon Resistor	4.7K 1/4 J		01
R435	HF456820	Carbon Resistor	8.2K 1/4 J		01
R436	HF454100	Carbon Resistor	10.0 1/4 J		01
R437	HF458220	Carbon Resistor	220.0K 1/4 J		01
R438	HF858100	Carbon Resistor	100.0K 1/4 J		01
R439	HF456820	Carbon Resistor	8.2K 1/4 J		01
R440	HF858100	Carbon Resistor	100.0K 1/4 J		01
R441	HF456470	Carbon Resistor	4.7K 1/4 J		01
R442	HF858100	Carbon Resistor	100.0K 1/4 J		01
R443	HF456330	Carbon Resistor	3.3K 1/4 J		01
R444	HF456510	Carbon Resistor	5.1K 1/4 J		01
R445	HF456510	Carbon Resistor	5.1K 1/4 J		01
R446	HF454220	Carbon Resistor	22.0 1/4 J		01
R447	HF456510	Carbon Resistor	5.1K 1/4 J		01
R448	HF456510	Carbon Resistor	5.1K 1/4 J		01
R449	HF454220	Carbon Resistor	22.0 1/4 J		01
R450	HF455220	Carbon Resistor	220.0 1/4 J		01
R451	HF455220	Carbon Resistor	220.0 1/4 J		01
R452	HF456470	Carbon Resistor	4.7K 1/4 J		01
R453	HF457100	Carbon Resistor	10.0K 1/4 J		01
R454	HF454100	Carbon Resistor	10.0 1/4 J		01
R455	HF458220	Carbon Resistor	220.0K 1/4 J		01
R456	HF457180	Carbon Resistor	18.0K 1/4 J		01
-470	HF457180	Carbon Resistor	18.0K 1/4 J		01
R501	VV065200	Metal Film Resistor	4.7K 1/4 F		05
R502	VZ598300	Metal Film Resistor	510.0 1/4 F		01
R503	VV065200	Metal Film Resistor	4.7K 1/4 F		05
-505	VV065200	Metal Film Resistor	4.7K 1/4 F		05
R506	HF454100	Carbon Resistor	10.0 1/4 J		01
R507	HF454100	Carbon Resistor	10.0 1/4 J		01
R508	VV066100	Metal Film Resistor	47K 1/4 F		01
R509	VV066100	Metal Film Resistor	47K 1/4 F		01
R510	HF454100	Carbon Resistor	10.0 1/4 J		01
R511	VV065100	Metal Film Resistor	2.2K 1/4 F		01

*: New Parts

RANK : Japan only

GF24/12
GF16/12
GF12/12

REF NO.	PART NO.	DESCRIPTION		REMARKS	QTY	RANK
R512	VV065400	Metal Film Resistor	8.2K 1/4 F			01
R513	VV064900	Metal Film Resistor	20.0 1/4 F			01
R514	VV065900	Metal Film Resistor	24K 1/4 F			01
R515	VV065100	Metal Film Resistor	2.2K 1/4 F			01
R516	VV065400	Metal Film Resistor	8.2K 1/4 F			01
R517	VV065900	Metal Film Resistor	24K 1/4 F			01
R518	HF454100	Carbon Resistor	10.0 1/4 J			01
R519	VV065200	Metal Film Resistor	4.7K 1/4 F			05
R520	VV065200	Metal Film Resistor	4.7K 1/4 F			05
R521	HF458220	Carbon Resistor	220.0K 1/4 J			01
R522	HF457150	Carbon Resistor	15.0K 1/4 J			01
R523	HF457300	Carbon Resistor	30.0K 1/4 J			01
R524	HF454100	Carbon Resistor	10.0 1/4 J			01
R525	HF458220	Carbon Resistor	220.0K 1/4 J			01
R526	HF458220	Carbon Resistor	220.0K 1/4 J			01
R527	HF457100	Carbon Resistor	10.0K 1/4 J			01
R528	HF456470	Carbon Resistor	4.7K 1/4 J			01
R529	HF457330	Carbon Resistor	33.0K 1/4 J			01
R530	HF457100	Carbon Resistor	10.0K 1/4 J			01
R531	HF856560	Carbon Resistor	5.6K 1/4 J			01
R532	HF456470	Carbon Resistor	4.7K 1/4 J			01
R533	HF456820	Carbon Resistor	8.2K 1/4 J			01
R534	HF456470	Carbon Resistor	4.7K 1/4 J			01
R535	HF456820	Carbon Resistor	8.2K 1/4 J			01
R536	HF454100	Carbon Resistor	10.0 1/4 J			01
R537	HF458220	Carbon Resistor	220.0K 1/4 J			01
R538	HF858100	Carbon Resistor	100.0K 1/4 J			01
R539	HF456820	Carbon Resistor	8.2K 1/4 J			01
R540	HF858100	Carbon Resistor	100.0K 1/4 J			01
R541	HF456470	Carbon Resistor	4.7K 1/4 J			01
R542	HF858100	Carbon Resistor	100.0K 1/4 J			01
R543	HF456330	Carbon Resistor	3.3K 1/4 J			01
R544	HF456510	Carbon Resistor	5.1K 1/4 J			01
R545	HF456510	Carbon Resistor	5.1K 1/4 J			01
R546	HF454220	Carbon Resistor	22.0 1/4 J			01
R547	HF456510	Carbon Resistor	5.1K 1/4 J			01
R548	HF456510	Carbon Resistor	5.1K 1/4 J			01
R549	HF454220	Carbon Resistor	22.0 1/4 J			01
R550	HF455220	Carbon Resistor	220.0 1/4 J			01
R551	HF457180	Carbon Resistor	18.0K 1/4 J			01
R552	HF455220	Carbon Resistor	220.0 1/4 J			01
R553	HF456470	Carbon Resistor	4.7K 1/4 J			01
R554	HF457100	Carbon Resistor	10.0K 1/4 J			01
R555	HF454100	Carbon Resistor	10.0 1/4 J			01
R556	HF458220	Carbon Resistor	220.0K 1/4 J			01
R557	HF457180	Carbon Resistor	18.0K 1/4 J			01
-570	HF457180	Carbon Resistor	18.0K 1/4 J			01
R601	VV065200	Metal Film Resistor	4.7K 1/4 F			05
R602	VZ598300	Metal Film Resistor	510.0 1/4 F			01
R603	VV065200	Metal Film Resistor	4.7K 1/4 F			05
-605	VV065200	Metal Film Resistor	4.7K 1/4 F			05
R606	HF454100	Carbon Resistor	10.0 1/4 J			01
R607	HF454100	Carbon Resistor	10.0 1/4 J			01
R608	VV066100	Metal Film Resistor	47K 1/4 F			01
R609	VV066100	Metal Film Resistor	47K 1/4 F			01
R610	HF454100	Carbon Resistor	10.0 1/4 J			01
R611	VV065100	Metal Film Resistor	2.2K 1/4 F			01
R612	VV065400	Metal Film Resistor	8.2K 1/4 F			01
R613	VV064900	Metal Film Resistor	20.0 1/4 F			01
R614	VV065900	Metal Film Resistor	24K 1/4 F			01
R615	VV065100	Metal Film Resistor	2.2K 1/4 F			01
R616	VV065400	Metal Film Resistor	8.2K 1/4 F			01
R617	VV065900	Metal Film Resistor	24K 1/4 F			01
R618	HF454100	Carbon Resistor	10.0 1/4 J			01
R619	VV065200	Metal Film Resistor	4.7K 1/4 F			05
R620	VV065200	Metal Film Resistor	4.7K 1/4 F			05
R621	HF458220	Carbon Resistor	220.0K 1/4 J			01
R622	HF457150	Carbon Resistor	15.0K 1/4 J			01
R623	HF457300	Carbon Resistor	30.0K 1/4 J			01
R624	HF454100	Carbon Resistor	10.0 1/4 J			01

* : New Parts

RANK : Japan only

REF NO.	PART NO.	DESCRIPTION	REMARKS	QTY	RANK
R625	HF458220	Carbon Resistor	220.0K 1/4 J		01
R626	HF458220	Carbon Resistor	220.0K 1/4 J		01
R627	HF457100	Carbon Resistor	10.0K 1/4 J		01
R628	HF456470	Carbon Resistor	4.7K 1/4 J		01
R629	HF457330	Carbon Resistor	33.0K 1/4 J		01
R630	HF457100	Carbon Resistor	10.0K 1/4 J		01
R631	HF856560	Carbon Resistor	5.6K 1/4 J		01
R632	HF456470	Carbon Resistor	4.7K 1/4 J		01
R633	HF456820	Carbon Resistor	8.2K 1/4 J		01
R634	HF456470	Carbon Resistor	4.7K 1/4 J		01
R635	HF456820	Carbon Resistor	8.2K 1/4 J		01
R636	HF454100	Carbon Resistor	10.0 1/4 J		01
R637	HF458220	Carbon Resistor	220.0K 1/4 J		01
R638	HF858100	Carbon Resistor	100.0K 1/4 J		01
R639	HF456820	Carbon Resistor	8.2K 1/4 J		01
R640	HF858100	Carbon Resistor	100.0K 1/4 J		01
R641	HF456470	Carbon Resistor	4.7K 1/4 J		01
R642	HF858100	Carbon Resistor	100.0K 1/4 J		01
R643	HF456330	Carbon Resistor	3.3K 1/4 J		01
R644	HF456510	Carbon Resistor	5.1K 1/4 J		01
R645	HF456510	Carbon Resistor	5.1K 1/4 J		01
R646	HF454220	Carbon Resistor	22.0 1/4 J		01
R647	HF456510	Carbon Resistor	5.1K 1/4 J		01
R648	HF456510	Carbon Resistor	5.1K 1/4 J		01
R649	HF454220	Carbon Resistor	22.0 1/4 J		01
R650	HF455220	Carbon Resistor	220.0 1/4 J		01
R651	HF457180	Carbon Resistor	18.0K 1/4 J		01
R652	HF455220	Carbon Resistor	220.0 1/4 J		01
R653	HF456470	Carbon Resistor	4.7K 1/4 J		01
R654	HF457100	Carbon Resistor	10.0K 1/4 J		01
R655	HF454100	Carbon Resistor	10.0 1/4 J		01
R656	HF458220	Carbon Resistor	220.0K 1/4 J		01
R657	HF457180	Carbon Resistor	18.0K 1/4 J		01
-670	HF457180	Carbon Resistor	18.0K 1/4 J		01
R701	VV065200	Metal Film Resistor	4.7K 1/4 F		05
R702	VZ598300	Metal Film Resistor	510.0 1/4 F		01
R703	VV065200	Metal Film Resistor	4.7K 1/4 F		05
-705	VV065200	Metal Film Resistor	4.7K 1/4 F		05
R706	HF454100	Carbon Resistor	10.0 1/4 J		01
R707	HF454100	Carbon Resistor	10.0 1/4 J		01
R708	VV066100	Metal Film Resistor	47K 1/4 F		01
R709	VV066100	Metal Film Resistor	47K 1/4 F		01
R710	HF454100	Carbon Resistor	10.0 1/4 J		01
R711	VV065100	Metal Film Resistor	2.2K 1/4 F		01
R712	VV065400	Metal Film Resistor	8.2K 1/4 F		01
R713	VV064900	Metal Film Resistor	20.0 1/4 F		01
R714	VV065900	Metal Film Resistor	24K 1/4 F		01
R715	VV065100	Metal Film Resistor	2.2K 1/4 F		01
R716	VV065400	Metal Film Resistor	8.2K 1/4 F		01
R717	VV065900	Metal Film Resistor	24K 1/4 F		01
R718	HF454100	Carbon Resistor	10.0 1/4 J		01
R719	VV065200	Metal Film Resistor	4.7K 1/4 F		05
R720	VV065200	Metal Film Resistor	4.7K 1/4 F		05
R721	HF458220	Carbon Resistor	220.0K 1/4 J		01
R722	HF457150	Carbon Resistor	15.0K 1/4 J		01
R723	HF457300	Carbon Resistor	30.0K 1/4 J		01
R724	HF454100	Carbon Resistor	10.0 1/4 J		01
R725	HF458220	Carbon Resistor	220.0K 1/4 J		01
R726	HF458220	Carbon Resistor	220.0K 1/4 J		01
R727	HF457100	Carbon Resistor	10.0K 1/4 J		01
R728	HF456470	Carbon Resistor	4.7K 1/4 J		01
R729	HF457330	Carbon Resistor	33.0K 1/4 J		01
R730	HF457100	Carbon Resistor	10.0K 1/4 J		01
R731	HF856560	Carbon Resistor	5.6K 1/4 J		01
R732	HF456470	Carbon Resistor	4.7K 1/4 J		01
R733	HF456820	Carbon Resistor	8.2K 1/4 J		01
R734	HF456470	Carbon Resistor	4.7K 1/4 J		01
R735	HF456820	Carbon Resistor	8.2K 1/4 J		01
R736	HF454100	Carbon Resistor	10.0 1/4 J		01
R737	HF458220	Carbon Resistor	220.0K 1/4 J		01

*: New Parts

RANK : Japan only

REF NO.	PART NO.	DESCRIPTION		REMARKS	QTY	RANK
R738	HF858100	Carbon Resistor	100.0K 1/4 J			01
R739	HF456820	Carbon Resistor	8.2K 1/4 J			01
R740	HF858100	Carbon Resistor	100.0K 1/4 J			01
R741	HF456470	Carbon Resistor	4.7K 1/4 J			01
R742	HF858100	Carbon Resistor	100.0K 1/4 J			01
R743	HF456330	Carbon Resistor	3.3K 1/4 J			01
R744	HF456510	Carbon Resistor	5.1K 1/4 J			01
R745	HF456510	Carbon Resistor	5.1K 1/4 J			01
R746	HF454220	Carbon Resistor	22.0 1/4 J			01
R747	HF456510	Carbon Resistor	5.1K 1/4 J			01
R748	HF456510	Carbon Resistor	5.1K 1/4 J			01
R749	HF454220	Carbon Resistor	22.0 1/4 J			01
R750	HF455220	Carbon Resistor	220.0 1/4 J			01
R751	HF457180	Carbon Resistor	18.0K 1/4 J			01
R752	HF455220	Carbon Resistor	220.0 1/4 J			01
R753	HF456470	Carbon Resistor	4.7K 1/4 J			01
R754	HF457100	Carbon Resistor	10.0K 1/4 J			01
R755	HF454100	Carbon Resistor	10.0 1/4 J			01
R756	HF458220	Carbon Resistor	220.0K 1/4 J			01
R757	HF457180	Carbon Resistor	18.0K 1/4 J			01
-770	HF457180	Carbon Resistor	18.0K 1/4 J			01
R801	VV065200	Metal Film Resistor	4.7K 1/4 F			05
R802	VZ598300	Metal Film Resistor	510.0 1/4 F			01
R803	VV065200	Metal Film Resistor	4.7K 1/4 F			05
-805	VV065200	Metal Film Resistor	4.7K 1/4 F			05
R806	HF454100	Carbon Resistor	10.0 1/4 J			01
R807	HF454100	Carbon Resistor	10.0 1/4 J			01
R808	VV066100	Metal Film Resistor	47K 1/4 F			01
R809	VV066100	Metal Film Resistor	47K 1/4 F			01
R810	HF454100	Carbon Resistor	10.0 1/4 J			01
R811	VV065100	Metal Film Resistor	2.2K 1/4 F			01
R812	VV065400	Metal Film Resistor	8.2K 1/4 F			01
R813	VV064900	Metal Film Resistor	20.0 1/4 F			01
R814	VV065900	Metal Film Resistor	24K 1/4 F			01
R815	VV065100	Metal Film Resistor	2.2K 1/4 F			01
R816	VV065400	Metal Film Resistor	8.2K 1/4 F			01
R817	VV065900	Metal Film Resistor	24K 1/4 F			01
R818	HF454100	Carbon Resistor	10.0 1/4 J			01
R819	VV065200	Metal Film Resistor	4.7K 1/4 F			05
R820	VV065200	Metal Film Resistor	4.7K 1/4 F			05
R821	HF458220	Carbon Resistor	220.0K 1/4 J			01
R822	HF457150	Carbon Resistor	15.0K 1/4 J			01
R823	HF457300	Carbon Resistor	30.0K 1/4 J			01
R824	HF454100	Carbon Resistor	10.0 1/4 J			01
R825	HF458220	Carbon Resistor	220.0K 1/4 J			01
R826	HF458220	Carbon Resistor	220.0K 1/4 J			01
R827	HF457100	Carbon Resistor	10.0K 1/4 J			01
R828	HF456470	Carbon Resistor	4.7K 1/4 J			01
R829	HF457330	Carbon Resistor	33.0K 1/4 J			01
R830	HF457100	Carbon Resistor	10.0K 1/4 J			01
R831	HF856560	Carbon Resistor	5.6K 1/4 J			01
R832	HF456470	Carbon Resistor	4.7K 1/4 J			01
R833	HF456820	Carbon Resistor	8.2K 1/4 J			01
R834	HF456470	Carbon Resistor	4.7K 1/4 J			01
R835	HF456820	Carbon Resistor	8.2K 1/4 J			01
R836	HF454100	Carbon Resistor	10.0 1/4 J			01
R837	HF458220	Carbon Resistor	220.0K 1/4 J			01
R838	HF858100	Carbon Resistor	100.0K 1/4 J			01
R839	HF456820	Carbon Resistor	8.2K 1/4 J			01
R840	HF858100	Carbon Resistor	100.0K 1/4 J			01
R841	HF456470	Carbon Resistor	4.7K 1/4 J			01
R842	HF858100	Carbon Resistor	100.0K 1/4 J			01
R843	HF456330	Carbon Resistor	3.3K 1/4 J			01
R844	HF456510	Carbon Resistor	5.1K 1/4 J			01
R845	HF456510	Carbon Resistor	5.1K 1/4 J			01
R846	HF454220	Carbon Resistor	22.0 1/4 J			01
R847	HF456510	Carbon Resistor	5.1K 1/4 J			01
R848	HF456510	Carbon Resistor	5.1K 1/4 J			01
R849	HF454220	Carbon Resistor	22.0 1/4 J			01
R850	HF455220	Carbon Resistor	220.0 1/4 J			01

* : New Parts

RANK : Japan only

REF NO.	PART NO.	DESCRIPTION	REMARKS	QTY	RANK
R851	HF457180	Carbon Resistor	18.0K 1/4 J		01
R852	HF455220	Carbon Resistor	220.0 1/4 J		01
R853	HF456470	Carbon Resistor	4.7K 1/4 J		01
R854	HF457100	Carbon Resistor	10.0K 1/4 J		01
R855	HF454100	Carbon Resistor	10.0 1/4 J		01
R856	HF458220	Carbon Resistor	220.0K 1/4 J		01
R857	HF457180	Carbon Resistor	18.0K 1/4 J		01
-870	HF457180	Carbon Resistor	18.0K 1/4 J		01
SW101	VZ587700	Push Switch		1ch(PAD,HPF,PRE3-4,PRE5-6,	01
-109	VZ587700	Push Switch		ON,1-2,3-4,ST,PFL)	01
SW201	VZ587700	Push Switch		2ch(PAD,HPF,PRE3-4,PRE5-6,	01
-209	VZ587700	Push Switch		ON,1-2,3-4,ST,PFL)	01
SW301	VZ587700	Push Switch		3ch(PAD,HPF,PRE3-4,PRE5-6,	01
-309	VZ587700	Push Switch		ON,1-2,3-4,ST,PFL)	01
SW401	VZ587700	Push Switch		4ch(PAD,HPF,PRE3-4,PRE5-6,	01
-409	VZ587700	Push Switch		ON,1-2,3-4,ST,PFL)	01
SW501	VZ587700	Push Switch		5ch(PAD,HPF,PRE3-4,PRE5-6,	01
-509	VZ587700	Push Switch		ON,1-2,3-4,ST,PFL)	01
SW601	VZ587700	Push Switch		6ch(PAD,HPF,PRE3-4,PRE5-6,	01
-609	VZ587700	Push Switch		ON,1-2,3-4,ST,PFL)	01
SW701	VZ587700	Push Switch		7ch(PAD,HPF,PRE3-4,PRE5-6,	01
-709	VZ587700	Push Switch		ON,1-2,3-4,ST,PFL)	01
SW801	VZ587700	Push Switch		8ch(PAD,HPF,PRE3-4,PRE5-6,	01
-809	VZ587700	Push Switch		ON,1-2,3-4,ST,PFL)	01
VR101	VU804500	Rotary Variable Resistor	RD 5.0K RK09K113	1ch(PAD)	04
VR102	V3161000	Rotary Variable Resistor	B 50.0K RK09D113	1ch(LOW)	04
VR103	V3161000	Rotary Variable Resistor	B 50.0K RK09D113	1ch(HIGH)	04
VR104	VZ611200	Rotary Variable Resistor	C 100K RK12L123	1ch(MID-f)	04
* VR105	V3161100	Rotary Variable Resistor	W 20.0K RK09D113	1ch(MID)	04
VR106	VU804100	Slide Variable Resistor	RS6011YG6036-10KA	1ch(Fader)	04
VR107	VZ610800	Rotary Variable Resistor	AC 20K RK12L123	1ch(PAN)	03
VR108	VU804600	Rotary Variable Resistor	A 20.0K RK09K113	1ch(A1-A6)	04
-113	VU804600	Rotary Variable Resistor	A 20.0K RK09K113		04
VR201	VU804500	Rotary Variable Resistor	RD 5.0K RK09K113	2ch(PAD)	04
VR202	V3161000	Rotary Variable Resistor	B 50.0K RK09D113	2ch(LOW)	04
VR203	V3161000	Rotary Variable Resistor	B 50.0K RK09D113	2ch(HIGH)	04
VR204	VZ611200	Rotary Variable Resistor	C 100K RK12L123	2ch(MID-f)	04
* VR205	V3161100	Rotary Variable Resistor	W 20.0K RK09D113	2ch(MID)	04
VR206	VU804100	Slide Variable Resistor	RS6011YG6036-10KA	2ch(Fader)	04
VR207	VZ610800	Rotary Variable Resistor	AC 20K RK12L123	2ch(PAN)	03
VR208	VU804600	Rotary Variable Resistor	A 20.0K RK09K113	2ch(A1-A6)	04
-213	VU804600	Rotary Variable Resistor	A 20.0K RK09K113		04
VR301	VU804500	Rotary Variable Resistor	RD 5.0K RK09K113	3ch(PAD)	04
VR302	V3161000	Rotary Variable Resistor	B 50.0K RK09D113	3ch(LOW)	04
VR303	V3161000	Rotary Variable Resistor	B 50.0K RK09D113	3ch(HIGH)	04
VR304	VZ611200	Rotary Variable Resistor	C 100K RK12L123	3ch(MID-f)	04
* VR305	V3161100	Rotary Variable Resistor	W 20.0K RK09D113	3ch(MID)	04
VR306	VU804100	Slide Variable Resistor	RS6011YG6036-10KA	3ch(Fader)	04
VR307	VZ610800	Rotary Variable Resistor	AC 20K RK12L123	3ch(PAN)	03
VR308	VU804600	Rotary Variable Resistor	A 20.0K RK09K113	3ch(A1-A6)	04
-313	VU804600	Rotary Variable Resistor	A 20.0K RK09K113		04
VR401	VU804500	Rotary Variable Resistor	RD 5.0K RK09K113	4ch(PAD)	04
VR402	V3161000	Rotary Variable Resistor	B 50.0K RK09D113	4ch(LOW)	04
VR403	V3161000	Rotary Variable Resistor	B 50.0K RK09D113	4ch(HIGH)	04
VR404	VZ611200	Rotary Variable Resistor	C 100K RK12L123	4ch(MID-f)	04
* VR405	V3161100	Rotary Variable Resistor	W 20.0K RK09D113	4ch(MID)	04
VR406	VU804100	Slide Variable Resistor	RS6011YG6036-10KA	4ch(Fader)	04
VR407	VZ610800	Rotary Variable Resistor	AC 20K RK12L123	4ch(PAN)	03
VR408	VU804600	Rotary Variable Resistor	A 20.0K RK09K113	4ch(A1-A6)	04
-413	VU804600	Rotary Variable Resistor	A 20.0K RK09K113		04
VR501	VU804500	Rotary Variable Resistor	RD 5.0K RK09K113	5ch(PAD)	04
VR502	V3161000	Rotary Variable Resistor	B 50.0K RK09D113	5ch(LOW)	04
VR503	V3161000	Rotary Variable Resistor	B 50.0K RK09D113	5ch(HIGH)	04
VR504	VZ611200	Rotary Variable Resistor	C 100K RK12L123	5ch(MID-f)	04
* VR505	V3161100	Rotary Variable Resistor	W 20.0K RK09D113	5ch(MID)	04
VR506	VU804100	Slide Variable Resistor	RS6011YG6036-10KA	5ch(Fader)	04
VR507	VZ610800	Rotary Variable Resistor	AC 20K RK12L123	5ch(PAN)	03
VR508	VU804600	Rotary Variable Resistor	A 20.0K RK09K113	5ch(A1-A6)	04
-513	VU804600	Rotary Variable Resistor	A 20.0K RK09K113		04
VR601	VU804500	Rotary Variable Resistor	RD 5.0K RK09K113	6ch(PAD)	04

*: New Parts

RANK : Japan only

REF NO.	PART NO.	DESCRIPTION		REMARKS	QTY	RANK
VR602	V3161000	Rotary Variable Resistor	B 50.0K RK09D113	6ch(LOW)		04
VR603	V3161000	Rotary Variable Resistor	B 50.0K RK09D113	6ch(HIGH)		04
VR604	VZ611200	Rotary Variable Resistor	C 100K RK12L123	6ch(MID-f)		
* VR605	V3161100	Rotary Variable Resistor	W 20.0K RK09D113	6ch(MID)		
VR606	VU804100	Slide Variable Resistor	RS6011YG6036-10KA	6ch(Fader)		04
VR607	VZ610800	Rotary Variable Resistor	AC 20K RK12L123	6ch(PAN)		03
VR608	VU804600	Rotary Variable Resistor	A 20.0K RK09K113	6ch(A1-A6)		04
-613	VU804600	Rotary Variable Resistor	A 20.0K RK09K113			04
VR701	VU804500	Rotary Variable Resistor	RD 5.0K RK09K113	7ch(PAD)		04
VR702	V3161000	Rotary Variable Resistor	B 50.0K RK09D113	7ch(LOW)		04
VR703	V3161000	Rotary Variable Resistor	B 50.0K RK09D113	7ch(HIGH)		04
VR704	VZ611200	Rotary Variable Resistor	C 100K RK12L123	7ch(MID-f)		
* VR705	V3161100	Rotary Variable Resistor	W 20.0K RK09D113	7ch(MID)		
VR706	VU804100	Slide Variable Resistor	RS6011YG6036-10KA	7ch(Fader)		04
VR707	VZ610800	Rotary Variable Resistor	AC 20K RK12L123	7ch(PAN)		03
VR708	VU804600	Rotary Variable Resistor	A 20.0K RK09K113	7ch(A1-A6)		04
-713	VU804600	Rotary Variable Resistor	A 20.0K RK09K113			04
VR801	VU804500	Rotary Variable Resistor	RD 5.0K RK09K113	8ch(PAD)		04
VR802	V3161000	Rotary Variable Resistor	B 50.0K RK09D113	8ch(LOW)		04
VR803	V3161000	Rotary Variable Resistor	B 50.0K RK09D113	8ch(HIGH)		04
VR804	VZ611200	Rotary Variable Resistor	C 100K RK12L123	8ch(MID-f)		
* VR805	V3161100	Rotary Variable Resistor	W 20.0K RK09D113	8ch(MID)		
VR806	VU804100	Slide Variable Resistor	RS6011YG6036-10KA	8ch(Fader)		04
VR807	VZ610800	Rotary Variable Resistor	AC 20K RK12L123	8ch(PAN)		03
VR808	VU804600	Rotary Variable Resistor	A 20.0K RK09K113	8ch(A1-A6)		04
-813	VU804600	Rotary Variable Resistor	A 20.0K RK09K113			04
*	V2884100	Circuit Board	IN12	GF24/12:9-20ch, (XV333B0) GF16/12:1-12ch		
*	V3297600	Earth Terminal				
.....	VV307300	Spacer, LED				01
.....	VZ968500	Button	NO.947 CD-GRAY			01
.....	VZ968600	Button	NO.947 CD-GRAY			01
.....	VZ968700	Button	NO.946 CL-GRAY			01
.....	V2947200	Button	MX-BLUE			
C101	UM417100	Electrolytic Cap.	10.00 25.0V			01
C102	UM417100	Electrolytic Cap.	10.00 25.0V			01
C103	VZ353600	Ceramic Cap.-B	220P 50V K			01
C104	VZ353600	Ceramic Cap.-B	220P 50V K			01
C105	VZ353800	Ceramic Cap.-B	470P 50V K			01
C106	VZ352700	Ceramic Capacitor-SL	10P 50V J			01
C107	VV330700	Electrolytic Cap.-SM	470.00 10.0V			01
C108	VZ353800	Ceramic Cap.-B	470P 50V K			01
C109	VZ352700	Ceramic Capacitor-SL	10P 50V J			01
C110	VZ353700	Ceramic Cap.-B	330P 50V K			01
C111	VZ353000	Ceramic Capacitor-SL	33P 50V J			01
C112	UM417100	Electrolytic Cap.	10.00 25.0V			01
C113	VZ597300	Mylar Capacitor	0.091 50V J			01
C114	VZ597300	Mylar Capacitor	0.091 50V J			01
C115	VZ353500	Ceramic Capacitor-SL	100P 50V J			01
C116	UM417100	Electrolytic Cap.	10.00 25.0V			01
C117	UM417100	Electrolytic Cap.	10.00 25.0V			01
C118	VV062300	Mylar Capacitor	0.039 50V J			01
C119	VV190000	Mylar Capacitor	820P 50V J			01
C120	VZ353200	Ceramic Capacitor-SL	47P 50V J			01
C121	VZ353500	Ceramic Capacitor-SL	100P 50V J			01
C122	VV060800	Mylar Capacitor	3900P 50V J			01
C123	VZ353500	Ceramic Capacitor-SL	100P 50V J			01
C124	VV061400	Mylar Capacitor	0.010 50V J			01
C125	VZ352800	Ceramic Capacitor-SL	22P 50V J			01
C126	UJ667470	Electrolytic Cap.	47.00 25.0V			01
C127	UM416470	Electrolytic Cap.	4.70 50.0V			01
C128	VV062400	Mylar Capacitor	0.047 50V J			01
C129	VZ354000	Ceramic Capacitor-F	0.0100 50V Z			01
C130	VZ354000	Ceramic Capacitor-F	0.0100 50V Z			01
C133	VZ354000	Ceramic Capacitor-F	0.0100 50V Z			01
C134	VZ354000	Ceramic Capacitor-F	0.0100 50V Z			01
C135	UM417100	Electrolytic Cap.	10.00 25.0V			01
C136	VZ353900	Ceramic Cap.-B	1000P 50V K			01
C137	VZ353500	Ceramic Capacitor-SL	100P 50V J			01

* : New Parts

RANK : Japan only

REF NO.	PART NO.	DESCRIPTION		REMARKS	QTY	RANK
C138	VZ353500	Ceramic Capacitor-SL	100P 50V J			01
C139	VZ353200	Ceramic Capacitor-SL	47P 50V J			01
C140	UJ667470	Electrolytic Cap.	47.00 25.0V			01
C141	UM417100	Electrolytic Cap.	10.00 25.0V			01
C142	VZ353500	Ceramic Capacitor-SL	100P 50V J			01
C143	VZ353500	Ceramic Capacitor-SL	100P 50V J			01
C144	VZ353200	Ceramic Capacitor-SL	47P 50V J			01
C145	UJ667470	Electrolytic Cap.	47.00 25.0V			01
C201	UM417100	Electrolytic Cap.	10.00 25.0V			01
C202	UM417100	Electrolytic Cap.	10.00 25.0V			01
C203	VZ353600	Ceramic Cap.-B	220P 50V K			01
C204	VZ353600	Ceramic Cap.-B	220P 50V K			01
C205	VZ353800	Ceramic Cap.-B	470P 50V K			01
C206	VZ352700	Ceramic Capacitor-SL	10P 50V J			01
C207	VV330700	Electrolytic Cap.-SM	470.00 10.0V			01
C208	VZ353800	Ceramic Cap.-B	470P 50V K			01
C209	VZ352700	Ceramic Capacitor-SL	10P 50V J			01
C210	VZ353700	Ceramic Cap.-B	330P 50V K			01
C211	VZ353000	Ceramic Capacitor-SL	33P 50V J			01
C212	UM417100	Electrolytic Cap.	10.00 25.0V			01
C213	VZ597300	Mylar Capacitor	0.091 50V J			01
C214	VZ597300	Mylar Capacitor	0.091 50V J			01
C215	VZ353500	Ceramic Capacitor-SL	100P 50V J			01
C216	UM417100	Electrolytic Cap.	10.00 25.0V			01
C217	UM417100	Electrolytic Cap.	10.00 25.0V			01
C218	VV062300	Mylar Capacitor	0.039 50V J			01
C219	VV190000	Mylar Capacitor	820P 50V J			01
C220	VZ353200	Ceramic Capacitor-SL	47P 50V J			01
C221	VZ353500	Ceramic Capacitor-SL	100P 50V J			01
C222	VV060800	Mylar Capacitor	3900P 50V J			01
C223	VZ353500	Ceramic Capacitor-SL	100P 50V J			01
C224	VV061400	Mylar Capacitor	0.010 50V J			01
C225	VZ352800	Ceramic Capacitor-SL	22P 50V J			01
C226	UJ667470	Electrolytic Cap.	47.00 25.0V			01
C227	UM416470	Electrolytic Cap.	4.70 50.0V			01
C228	VV062400	Mylar Capacitor	0.047 50V J			01
C229	UM417100	Electrolytic Cap.	10.00 25.0V			01
C230	VZ353500	Ceramic Capacitor-SL	100P 50V J			01
C231	VZ353500	Ceramic Capacitor-SL	100P 50V J			01
C232	VZ353200	Ceramic Capacitor-SL	47P 50V J			01
C233	VZ354000	Ceramic Capacitor-F	0.0100 50V Z			01
C234	VZ354000	Ceramic Capacitor-F	0.0100 50V Z			01
C235	UJ667470	Electrolytic Cap.	47.00 25.0V			01
C236	UM417100	Electrolytic Cap.	10.00 25.0V			01
C237	VZ353500	Ceramic Capacitor-SL	100P 50V J			01
C238	VZ353500	Ceramic Capacitor-SL	100P 50V J			01
C239	VZ353200	Ceramic Capacitor-SL	47P 50V J			01
C240	VZ354000	Ceramic Capacitor-F	0.0100 50V Z			01
C241	VZ354000	Ceramic Capacitor-F	0.0100 50V Z			01
C242	UJ667470	Electrolytic Cap.	47.00 25.0V			01
C301	UM417100	Electrolytic Cap.	10.00 25.0V			01
C302	UM417100	Electrolytic Cap.	10.00 25.0V			01
C303	VZ353600	Ceramic Cap.-B	220P 50V K			01
C304	VZ353600	Ceramic Cap.-B	220P 50V K			01
C305	VZ353800	Ceramic Cap.-B	470P 50V K			01
C306	VZ352700	Ceramic Capacitor-SL	10P 50V J			01
C307	VV330700	Electrolytic Cap.-SM	470.00 10.0V			01
C308	VZ353800	Ceramic Cap.-B	470P 50V K			01
C309	VZ352700	Ceramic Capacitor-SL	10P 50V J			01
C310	VZ353700	Ceramic Cap.-B	330P 50V K			01
C311	VZ353000	Ceramic Capacitor-SL	33P 50V J			01
C312	UM417100	Electrolytic Cap.	10.00 25.0V			01
C313	VZ597300	Mylar Capacitor	0.091 50V J			01
C314	VZ597300	Mylar Capacitor	0.091 50V J			01
C315	VZ353500	Ceramic Capacitor-SL	100P 50V J			01
C316	UM417100	Electrolytic Cap.	10.00 25.0V			01
C317	UM417100	Electrolytic Cap.	10.00 25.0V			01
C318	VV062300	Mylar Capacitor	0.039 50V J			01
C319	VV190000	Mylar Capacitor	820P 50V J			01
C320	VZ353200	Ceramic Capacitor-SL	47P 50V J			01

*: New Parts

RANK : Japan only

GF24/12
GF16/12
GF12/12

REF NO.	PART NO.	DESCRIPTION		REMARKS	QTY	RANK
C321	VZ353500	Ceramic Capacitor-SL	100P 50V J			01
C322	VV060800	Mylar Capacitor	3900P 50V J			01
C323	VZ353500	Ceramic Capacitor-SL	100P 50V J			01
C324	VV061400	Mylar Capacitor	0.010 50V J			01
C325	VZ352800	Ceramic Capacitor-SL	22P 50V J			01
C326	UJ667470	Electrolytic Cap.	47.00 25.0V			01
C327	UM416470	Electrolytic Cap.	4.70 50.0V			01
C328	VV062400	Mylar Capacitor	0.047 50V J			01
C329	VZ354000	Ceramic Capacitor-F	0.0100 50V Z			01
C330	VZ354000	Ceramic Capacitor-F	0.0100 50V Z			01
C333	VZ354000	Ceramic Capacitor-F	0.0100 50V Z			01
C334	VZ354000	Ceramic Capacitor-F	0.0100 50V Z			01
C335	UM417100	Electrolytic Cap.	10.00 25.0V			01
C336	VZ353900	Ceramic Cap.-B	1000P 50V K			01
C337	VZ353500	Ceramic Capacitor-SL	100P 50V J			01
C338	VZ353500	Ceramic Capacitor-SL	100P 50V J			01
C339	VZ353200	Ceramic Capacitor-SL	47P 50V J			01
C340	UJ667470	Electrolytic Cap.	47.00 25.0V			01
C341	UM417100	Electrolytic Cap.	10.00 25.0V			01
C342	VZ353500	Ceramic Capacitor-SL	100P 50V J			01
C343	VZ353500	Ceramic Capacitor-SL	100P 50V J			01
C344	VZ353200	Ceramic Capacitor-SL	47P 50V J			01
C345	UJ667470	Electrolytic Cap.	47.00 25.0V			01
C401	UM417100	Electrolytic Cap.	10.00 25.0V			01
C402	UM417100	Electrolytic Cap.	10.00 25.0V			01
C403	VZ353600	Ceramic Cap.-B	220P 50V K			01
C404	VZ353600	Ceramic Cap.-B	220P 50V K			01
C405	VZ353800	Ceramic Cap.-B	470P 50V K			01
C406	VZ352700	Ceramic Capacitor-SL	10P 50V J			01
C407	VV330700	electrolytic Cap.-SM	470.00 10.0V			01
C408	VZ353800	Ceramic Cap.-B	470P 50V K			01
C409	VZ352700	Ceramic Capacitor-SL	10P 50V J			01
C410	VZ353700	Ceramic Cap.-B	330P 50V K			01
C411	VZ353000	Ceramic Capacitor-SL	33P 50V J			01
C412	UM417100	Electrolytic Cap.	10.00 25.0V			01
C413	VZ597300	Mylar Capacitor	0.091 50V J			01
C414	VZ597300	Mylar Capacitor	0.091 50V J			01
C415	VZ353500	Ceramic Capacitor-SL	100P 50V J			01
C416	UM417100	Electrolytic Cap.	10.00 25.0V			01
C417	UM417100	Electrolytic Cap.	10.00 25.0V			01
C418	VV062300	Mylar Capacitor	0.039 50V J			01
C419	VV190000	Mylar Capacitor	820P 50V J			01
C420	VZ353200	Ceramic Capacitor-SL	47P 50V J			01
C421	VZ353500	Ceramic Capacitor-SL	100P 50V J			01
C422	VV060800	Mylar Capacitor	3900P 50V J			01
C423	VZ353500	Ceramic Capacitor-SL	100P 50V J			01
C424	VV061400	Mylar Capacitor	0.010 50V J			01
C425	VZ352800	Ceramic Capacitor-SL	22P 50V J			01
C426	UJ667470	Electrolytic Cap.	47.00 25.0V			01
C427	UM416470	Electrolytic Cap.	4.70 50.0V			01
C428	VV062400	Mylar Capacitor	0.047 50V J			01
C429	UM417100	Electrolytic Cap.	10.00 25.0V			01
C430	VZ353500	Ceramic Capacitor-SL	100P 50V J			01
C431	VZ353500	Ceramic Capacitor-SL	100P 50V J			01
C432	VZ353200	Ceramic Capacitor-SL	47P 50V J			01
C433	VZ354000	Ceramic Capacitor-F	0.0100 50V Z			01
C434	VZ354000	Ceramic Capacitor-F	0.0100 50V Z			01
C435	UJ667470	Electrolytic Cap.	47.00 25.0V			01
C436	UM417100	Electrolytic Cap.	10.00 25.0V			01
C437	VZ353500	Ceramic Capacitor-SL	100P 50V J			01
C438	VZ353500	Ceramic Capacitor-SL	100P 50V J			01
C439	VZ353200	Ceramic Capacitor-SL	47P 50V J			01
C440	VZ354000	Ceramic Capacitor-F	0.0100 50V Z			01
C441	VZ354000	Ceramic Capacitor-F	0.0100 50V Z			01
C442	UJ667470	Electrolytic Cap.	47.00 25.0V			01
C501	UM417100	Electrolytic Cap.	10.00 25.0V			01
C502	UM417100	Electrolytic Cap.	10.00 25.0V			01
C503	VZ353600	Ceramic Cap.-B	220P 50V K			01
C504	VZ353600	Ceramic Cap.-B	220P 50V K			01
C505	VZ353800	Ceramic Cap.-B	470P 50V K			01

* : New Parts

RANK : Japan only

REF NO.	PART NO.	DESCRIPTION		REMARKS	QTY	RANK
C506	VZ352700	Ceramic Capacitor-SL	10P 50V J			01
C507	VV330700	Electrolytic Cap.-SM	470.00 10.0V			01
C508	VZ353800	Ceramic Cap.-B	470P 50V K			01
C509	VZ352700	Ceramic Capacitor-SL	10P 50V J			01
C510	VZ353700	Ceramic Cap.-B	330P 50V K			01
C511	VZ353000	Ceramic Capacitor-SL	33P 50V J			01
C512	UM417100	Electrolytic Cap.	10.00 25.0V			01
C513	VZ597300	Mylar Capacitor	0.091 50V J			01
C514	VZ597300	Mylar Capacitor	0.091 50V J			01
C515	VZ353500	Ceramic Capacitor-SL	100P 50V J			01
C516	UM417100	Electrolytic Cap.	10.00 25.0V			01
C517	UM417100	Electrolytic Cap.	10.00 25.0V			01
C518	VV062300	Mylar Capacitor	0.039 50V J			01
C519	VV190000	Mylar Capacitor	820P 50V J			01
C520	VZ353200	Ceramic Capacitor-SL	47P 50V J			01
C521	VZ353500	Ceramic Capacitor-SL	100P 50V J			01
C522	VV060800	Mylar Capacitor	3900P 50V J			01
C523	VZ353500	Ceramic Capacitor-SL	100P 50V J			01
C524	VV061400	Mylar Capacitor	0.010 50V J			01
C525	VZ352800	Ceramic Capacitor-SL	22P 50V J			01
C526	UJ667470	Electrolytic Cap.	47.00 25.0V			01
C527	UM416470	Electrolytic Cap.	4.70 50.0V			01
C528	VV062400	Mylar Capacitor	0.047 50V J			01
C529	VZ354000	Ceramic Capacitor-F	0.0100 50V Z			01
C530	VZ354000	Ceramic Capacitor-F	0.0100 50V Z			01
C533	VZ354000	Ceramic Capacitor-F	0.0100 50V Z			01
C534	VZ354000	Ceramic Capacitor-F	0.0100 50V Z			01
C535	UM417100	Electrolytic Cap.	10.00 25.0V			01
C536	VZ353900	Ceramic Cap.-B	1000P 50V K			01
C537	VZ353500	Ceramic Capacitor-SL	100P 50V J			01
C538	VZ353500	Ceramic Capacitor-SL	100P 50V J			01
C539	VZ353200	Ceramic Capacitor-SL	47P 50V J			01
C540	UJ667470	Electrolytic Cap.	47.00 25.0V			01
C541	UM417100	Electrolytic Cap.	10.00 25.0V			01
C542	VZ353500	Ceramic Capacitor-SL	100P 50V J			01
C543	VZ353500	Ceramic Capacitor-SL	100P 50V J			01
C544	VZ353200	Ceramic Capacitor-SL	47P 50V J			01
C545	UJ667470	Electrolytic Cap.	47.00 25.0V			01
C601	UM417100	Electrolytic Cap.	10.00 25.0V			01
C602	UM417100	Electrolytic Cap.	10.00 25.0V			01
C603	VZ353600	Ceramic Cap.-B	220P 50V K			01
C604	VZ353600	Ceramic Cap.-B	220P 50V K			01
C605	VZ353800	Ceramic Cap.-B	470P 50V K			01
C606	VZ352700	Ceramic Capacitor-SL	10P 50V J			01
C607	VV330700	Electrolytic Cap.-SM	470.00 10.0V			01
C608	VZ353800	Ceramic Cap.-B	470P 50V K			01
C609	VZ352700	Ceramic Capacitor-SL	10P 50V J			01
C610	VZ353700	Ceramic Cap.-B	330P 50V K			01
C611	VZ353000	Ceramic Capacitor-SL	33P 50V J			01
C612	UM417100	Electrolytic Cap.	10.00 25.0V			01
C613	VZ597300	Mylar Capacitor	0.091 50V J			01
C614	VZ597300	Mylar Capacitor	0.091 50V J			01
C615	VZ353500	Ceramic Capacitor-SL	100P 50V J			01
C616	UM417100	Electrolytic Cap.	10.00 25.0V			01
C617	UM417100	Electrolytic Cap.	10.00 25.0V			01
C618	VV062300	Mylar Capacitor	0.039 50V J			01
C619	VV190000	Mylar Capacitor	820P 50V J			01
C620	VZ353200	Ceramic Capacitor-SL	47P 50V J			01
C621	VZ353500	Ceramic Capacitor-SL	100P 50V J			01
C622	VV060800	Mylar Capacitor	3900P 50V J			01
C623	VZ353500	Ceramic Capacitor-SL	100P 50V J			01
C624	VV061400	Mylar Capacitor	0.010 50V J			01
C625	VZ352800	Ceramic Capacitor-SL	22P 50V J			01
C626	UJ667470	Electrolytic Cap.	47.00 25.0V			01
C627	UM416470	Electrolytic Cap.	4.70 50.0V			01
C628	VV062400	Mylar Capacitor	0.047 50V J			01
C629	UM417100	Electrolytic Cap.	10.00 25.0V			01
C630	VZ353500	Ceramic Capacitor-SL	100P 50V J			01
C631	VZ353500	Ceramic Capacitor-SL	100P 50V J			01
C632	VZ353200	Ceramic Capacitor-SL	47P 50V J			01

*: New Parts

RANK : Japan only

GF24/12
GF16/12
GF12/12

REF NO.	PART NO.	DESCRIPTION		REMARKS	QTY	RANK
C633	VZ354000	Ceramic Capacitor-F	0.0100 50V Z			01
C634	VZ354000	Ceramic Capacitor-F	0.0100 50V Z			01
C635	UJ667470	Electrolytic Cap.	47.00 25.0V			01
C636	UM417100	Electrolytic Cap.	10.00 25.0V			01
C637	VZ353500	Ceramic Capacitor-SL	100P 50V J			01
C638	VZ353500	Ceramic Capacitor-SL	100P 50V J			01
C639	VZ353200	Ceramic Capacitor-SL	47P 50V J			01
C640	VZ354000	Ceramic Capacitor-F	0.0100 50V Z			01
C641	VZ354000	Ceramic Capacitor-F	0.0100 50V Z			01
C642	UJ667470	Electrolytic Cap.	47.00 25.0V			01
C701	UM417100	Electrolytic Cap.	10.00 25.0V			01
C702	UM417100	Electrolytic Cap.	10.00 25.0V			01
C703	VZ353600	Ceramic Cap.-B	220P 50V K			01
C704	VZ353600	Ceramic Cap.-B	220P 50V K			01
C705	VZ353800	Ceramic Cap.-B	470P 50V K			01
C706	VZ352700	Ceramic Capacitor-SL	10P 50V J			01
C707	VV330700	Electrolytic Cap.-SM	470.00 10.0V			01
C708	VZ353800	Ceramic Cap.-B	470P 50V K			01
C709	VZ352700	Ceramic Capacitor-SL	10P 50V J			01
C710	VZ353700	Ceramic Cap.-B	330P 50V K			01
C711	VZ353000	Ceramic Capacitor-SL	33P 50V J			01
C712	UM417100	Electrolytic Cap.	10.00 25.0V			01
C713	VZ597300	Mylar Capacitor	0.091 50V J			01
C714	VZ597300	Mylar Capacitor	0.091 50V J			01
C715	VZ353500	Ceramic Capacitor-SL	100P 50V J			01
C716	UM417100	Electrolytic Cap.	10.00 25.0V			01
C717	UM417100	Electrolytic Cap.	10.00 25.0V			01
C718	VV062300	Mylar Capacitor	0.039 50V J			01
C719	VV190000	Mylar Capacitor	820P 50V J			01
C720	VZ353200	Ceramic Capacitor-SL	47P 50V J			01
C721	VZ353500	Ceramic Capacitor-SL	100P 50V J			01
C722	VV060800	Mylar Capacitor	3900P 50V J			01
C723	VZ353500	Ceramic Capacitor-SL	100P 50V J			01
C724	VV061400	Mylar Capacitor	0.010 50V J			01
C725	VZ352800	Ceramic Capacitor-SL	22P 50V J			01
C726	UJ667470	Electrolytic Cap.	47.00 25.0V			01
C727	UM416470	Electrolytic Cap.	4.70 50.0V			01
C728	VV062400	Mylar Capacitor	0.047 50V J			01
C729	VZ354000	Ceramic Capacitor-F	0.0100 50V Z			01
C730	VZ354000	Ceramic Capacitor-F	0.0100 50V Z			01
C733	VZ354000	Ceramic Capacitor-F	0.0100 50V Z			01
C734	VZ354000	Ceramic Capacitor-F	0.0100 50V Z			01
C735	UM417100	Electrolytic Cap.	10.00 25.0V			01
C736	VZ353900	Ceramic Cap.-B	1000P 50V K			01
C737	VZ353500	Ceramic Capacitor-SL	100P 50V J			01
C738	VZ353500	Ceramic Capacitor-SL	100P 50V J			01
C739	VZ353200	Ceramic Capacitor-SL	47P 50V J			01
C740	UJ667470	Electrolytic Cap.	47.00 25.0V			01
C741	UM417100	Electrolytic Cap.	10.00 25.0V			01
C742	VZ353500	Ceramic Capacitor-SL	100P 50V J			01
C743	VZ353500	Ceramic Capacitor-SL	100P 50V J			01
C744	VZ353200	Ceramic Capacitor-SL	47P 50V J			01
C745	UJ667470	Electrolytic Cap.	47.00 25.0V			01
C801	UM417100	Electrolytic Cap.	10.00 25.0V			01
C802	UM417100	Electrolytic Cap.	10.00 25.0V			01
C803	VZ353600	Ceramic Cap.-B	220P 50V K			01
C804	VZ353600	Ceramic Cap.-B	220P 50V K			01
C805	VZ353800	Ceramic Cap.-B	470P 50V K			01
C806	VZ352700	Ceramic Capacitor-SL	10P 50V J			01
C807	VV330700	Electrolytic Cap.-SM	470.00 10.0V			01
C808	VZ353800	Ceramic Cap.-B	470P 50V K			01
C809	VZ352700	Ceramic Capacitor-SL	10P 50V J			01
C810	VZ353700	Ceramic Cap.-B	330P 50V K			01
C811	VZ353000	Ceramic Capacitor-SL	33P 50V J			01
C812	UM417100	Electrolytic Cap.	10.00 25.0V			01
C813	VZ597300	Mylar Capacitor	0.091 50V J			01
C814	VZ597300	Mylar Capacitor	0.091 50V J			01
C815	VZ353500	Ceramic Capacitor-SL	100P 50V J			01
C816	UM417100	Electrolytic Cap.	10.00 25.0V			01
C817	UM417100	Electrolytic Cap.	10.00 25.0V			01

* : New Parts

RANK : Japan only

REF NO.	PART NO.	DESCRIPTION		REMARKS	QTY	RANK
C818	VV062300	Mylar Capacitor	0.039 50V J			01
C819	VV190000	Mylar Capacitor	820P 50V J			01
C820	VZ353200	Ceramic Capacitor-SL	47P 50V J			01
C821	VZ353500	Ceramic Capacitor-SL	100P 50V J			01
C822	VV060800	Mylar Capacitor	3900P 50V J			01
C823	VZ353500	Ceramic Capacitor-SL	100P 50V J			01
C824	VV061400	Mylar Capacitor	0.010 50V J			01
C825	VZ352800	Ceramic Capacitor-SL	22P 50V J			01
C826	UJ667470	Electrolytic Cap.	47.00 25.0V			01
C827	UM416470	Electrolytic Cap.	4.70 50.0V			01
C828	VV062400	Mylar Capacitor	0.047 50V J			01
C829	UM417100	Electrolytic Cap.	10.00 25.0V			01
C830	VZ353500	Ceramic Capacitor-SL	100P 50V J			01
C831	VZ353500	Ceramic Capacitor-SL	100P 50V J			01
C832	VZ353200	Ceramic Capacitor-SL	47P 50V J			01
C833	VZ354000	Ceramic Capacitor-F	0.0100 50V Z			01
C834	VZ354000	Ceramic Capacitor-F	0.0100 50V Z			01
C835	UJ667470	Electrolytic Cap.	47.00 25.0V			01
C836	UM417100	Electrolytic Cap.	10.00 25.0V			01
C837	VZ353500	Ceramic Capacitor-SL	100P 50V J			01
C838	VZ353500	Ceramic Capacitor-SL	100P 50V J			01
C839	VZ353200	Ceramic Capacitor-SL	47P 50V J			01
C840	VZ354000	Ceramic Capacitor-F	0.0100 50V Z			01
C841	VZ354000	Ceramic Capacitor-F	0.0100 50V Z			01
C842	UJ667470	Electrolytic Cap.	47.00 25.0V			01
C901	UM417100	Electrolytic Cap.	10.00 25.0V			01
C902	UM417100	Electrolytic Cap.	10.00 25.0V			01
C903	VZ353600	Ceramic Cap.-B	220P 50V K			01
C904	VZ353600	Ceramic Cap.-B	220P 50V K			01
C905	VZ353800	Ceramic Cap.-B	470P 50V K			01
C906	VZ352700	Ceramic Capacitor-SL	10P 50V J			01
C907	VV330700	Electrolytic Cap.-SM	470.00 10.0V			01
C908	VZ353800	Ceramic Cap.-B	470P 50V K			01
C909	VZ352700	Ceramic Capacitor-SL	10P 50V J			01
C910	VZ353700	Ceramic Cap.-B	330P 50V K			01
C911	VZ353000	Ceramic Capacitor-SL	33P 50V J			01
C912	UM417100	Electrolytic Cap.	10.00 25.0V			01
C913	VZ597300	Mylar Capacitor	0.091 50V J			01
C914	VZ597300	Mylar Capacitor	0.091 50V J			01
C915	VZ353500	Ceramic Capacitor-SL	100P 50V J			01
C916	UM417100	Electrolytic Cap.	10.00 25.0V			01
C917	UM417100	Electrolytic Cap.	10.00 25.0V			01
C918	VV062300	Mylar Capacitor	0.039 50V J			01
C919	VV190000	Mylar Capacitor	820P 50V J			01
C920	VZ353200	Ceramic Capacitor-SL	47P 50V J			01
C921	VZ353500	Ceramic Capacitor-SL	100P 50V J			01
C922	VV060800	Mylar Capacitor	3900P 50V J			01
C923	VZ353500	Ceramic Capacitor-SL	100P 50V J			01
C924	VV061400	Mylar Capacitor	0.010 50V J			01
C925	VZ352800	Ceramic Capacitor-SL	22P 50V J			01
C926	UJ667470	Electrolytic Cap.	47.00 25.0V			01
C927	UM416470	Electrolytic Cap.	4.70 50.0V			01
C928	VV062400	Mylar Capacitor	0.047 50V J			01
C929	VZ354000	Ceramic Capacitor-F	0.0100 50V Z			01
C930	VZ354000	Ceramic Capacitor-F	0.0100 50V Z			01
C933	VZ354000	Ceramic Capacitor-F	0.0100 50V Z			01
C934	VZ354000	Ceramic Capacitor-F	0.0100 50V Z			01
C935	UM417100	Electrolytic Cap.	10.00 25.0V			01
C936	VZ353900	Ceramic Cap.-B	1000P 50V K			01
C937	VZ353500	Ceramic Capacitor-SL	100P 50V J			01
C938	VZ353500	Ceramic Capacitor-SL	100P 50V J			01
C939	VZ353200	Ceramic Capacitor-SL	47P 50V J			01
C940	UJ667470	Electrolytic Cap.	47.00 25.0V			01
C941	UM417100	Electrolytic Cap.	10.00 25.0V			01
C942	VZ353500	Ceramic Capacitor-SL	100P 50V J			01
C943	VZ353500	Ceramic Capacitor-SL	100P 50V J			01
C944	VZ353200	Ceramic Capacitor-SL	47P 50V J			01
C945	UJ667470	Electrolytic Cap.	47.00 25.0V			01
C1001	UM417100	Electrolytic Cap.	10.00 25.0V			01
C1002	UM417100	Electrolytic Cap.	10.00 25.0V			01

*: New Parts

RANK : Japan only

GF24/12
GF16/12
GF12/12

REF NO.	PART NO.	DESCRIPTION		REMARKS	QTY	RANK
C1003	VZ353600	Ceramic Cap.-B	220P 50V K			01
C1004	VZ353600	Ceramic Cap.-B	220P 50V K			01
C1005	VZ353800	Ceramic Cap.-B	470P 50V K			01
C1006	VZ352700	Ceramic Capacitor-SL	10P 50V J			01
C1007	VV330700	Electrolytic Cap.	470.00 10.0V			01
C1008	VZ353800	Ceramic Cap.-B	470P 50V K			01
C1009	VZ352700	Ceramic Capacitor-SL	10P 50V J			01
C1010	VZ353700	Ceramic Cap.-B	330P 50V K			01
C1011	VZ353000	Ceramic Capacitor-SL	33P 50V J			01
C1012	UM417100	Electrolytic Cap.	10.00 25.0V			01
C1013	VZ597300	Mylar Capacitor	0.091 50V J			01
C1014	VZ597300	Mylar Capacitor	0.091 50V J			01
C1015	VZ353500	Ceramic Capacitor-SL	100P 50V J			01
C1016	UM417100	Electrolytic Cap.	10.00 25.0V			01
C1017	UM417100	Electrolytic Cap.	10.00 25.0V			01
C1018	VV062300	Mylar Capacitor	0.039 50V J			01
C1019	VV190000	Mylar Capacitor	820P 50V J			01
C1020	VZ353200	Ceramic Capacitor-SL	47P 50V J			01
C1021	VZ353500	Ceramic Capacitor-SL	100P 50V J			01
C1022	VV060800	Mylar Capacitor	3900P 50V J			01
C1023	VZ353500	Ceramic Capacitor-SL	100P 50V J			01
C1024	VV061400	Mylar Capacitor	0.010 50V J			01
C1025	VZ352800	Ceramic Capacitor-SL	22P 50V J			01
C1026	UJ667470	Electrolytic Cap.	47.00 25.0V			01
C1027	UM416470	Electrolytic Cap.	4.70 50.0V			01
C1028	VV062400	Mylar Capacitor	0.047 50V J			01
C1029	UM417100	Electrolytic Cap.	10.00 25.0V			01
C1030	VZ353500	Ceramic Capacitor-SL	100P 50V J			01
C1031	VZ353500	Ceramic Capacitor-SL	100P 50V J			01
C1032	VZ353200	Ceramic Capacitor-SL	47P 50V J			01
C1033	VZ354000	Ceramic Capacitor-F	0.0100 50V Z			01
C1034	VZ354000	Ceramic Capacitor-F	0.0100 50V Z			01
C1035	UJ667470	Electrolytic Cap.	47.00 25.0V			01
C1036	UM417100	Electrolytic Cap.	10.00 25.0V			01
C1037	VZ353500	Ceramic Capacitor-SL	100P 50V J			01
C1038	VZ353500	Ceramic Capacitor-SL	100P 50V J			01
C1039	VZ353200	Ceramic Capacitor-SL	47P 50V J			01
C1040	VZ354000	Ceramic Capacitor-F	0.0100 50V Z			01
C1041	VZ354000	Ceramic Capacitor-F	0.0100 50V Z			01
C1042	UJ667470	Electrolytic Cap.	47.00 25.0V			01
C2001	UM417100	Electrolytic Cap.	10.00 25.0V			01
C2002	UM417100	Electrolytic Cap.	10.00 25.0V			01
C2003	VZ353600	Ceramic Cap.-B	220P 50V K			01
C2004	VZ353600	Ceramic Cap.-B	220P 50V K			01
C2005	VZ353800	Ceramic Cap.-B	470P 50V K			01
C2006	VZ352700	Ceramic Capacitor-SL	10P 50V J			01
C2007	VV330700	Electrolytic Cap.	470.00 10.0V			01
C2008	VZ353800	Ceramic Cap.-B	470P 50V K			01
C2009	VZ352700	Ceramic Capacitor-SL	10P 50V J			01
C2010	VZ353700	Ceramic Cap.-B	330P 50V K			01
C2011	VZ353000	Ceramic Capacitor-SL	33P 50V J			01
C2012	UM417100	Electrolytic Cap.	10.00 25.0V			01
C2013	VZ597300	Mylar Capacitor	0.091 50V J			01
C2014	VZ597300	Mylar Capacitor	0.091 50V J			01
C2015	VZ353500	Ceramic Capacitor-SL	100P 50V J			01
C2016	UM417100	Electrolytic Cap.	10.00 25.0V			01
C2017	UM417100	Electrolytic Cap.	10.00 25.0V			01
C2018	VV062300	Mylar Capacitor	0.039 50V J			01
C2019	VV190000	Mylar Capacitor	820P 50V J			01
C2020	VZ353200	Ceramic Capacitor-SL	47P 50V J			01
C2021	VZ353500	Ceramic Capacitor-SL	100P 50V J			01
C2022	VV060800	Mylar Capacitor	3900P 50V J			01
C2023	VZ353500	Ceramic Capacitor-SL	100P 50V J			01
C2024	VV061400	Mylar Capacitor	0.010 50V J			01
C2025	VZ352800	Ceramic Capacitor-SL	22P 50V J			01
C2026	UJ667470	Electrolytic Cap.	47.00 25.0V			01
C2027	UM416470	Electrolytic Cap.	4.70 50.0V			01
C2028	VV062400	Mylar Capacitor	0.047 50V J			01
C2029	VZ354000	Ceramic Capacitor-F	0.0100 50V Z			01
C2030	VZ354000	Ceramic Capacitor-F	0.0100 50V Z			01

* : New Parts

RANK : Japan only

REF NO.	PART NO.	DESCRIPTION		REMARKS	QTY	RANK
C2033	VZ354000	Ceramic Capacitor-F	0.0100 50V Z			01
C2034	VZ354000	Ceramic Capacitor-F	0.0100 50V Z			01
C2035	UM417100	Electrolytic Cap.	10.00 25.0V			01
C2036	VZ353900	Ceramic Cap.-B	1000P 50V K			01
C2037	VZ353500	Ceramic Capacitor-SL	100P 50V J			01
C2038	VZ353500	Ceramic Capacitor-SL	100P 50V J			01
C2039	VZ353200	Ceramic Capacitor-SL	47P 50V J			01
C2040	UJ667470	Electrolytic Cap.	47.00 25.0V			01
C2041	UM417100	Electrolytic Cap.	10.00 25.0V			01
C2042	VZ353500	Ceramic Capacitor-SL	100P 50V J			01
C2043	VZ353500	Ceramic Capacitor-SL	100P 50V J			01
C2044	VZ353200	Ceramic Capacitor-SL	47P 50V J			01
C2045	UJ667470	Electrolytic Cap.	47.00 25.0V			01
C3001	UM417100	Electrolytic Cap.	10.00 25.0V			01
C3002	UM417100	Electrolytic Cap.	10.00 25.0V			01
C3003	VZ353600	Ceramic Cap.-B	220P 50V K			01
C3004	VZ353600	Ceramic Cap.-B	220P 50V K			01
C3005	VZ353800	Ceramic Cap.-B	470P 50V K			01
C3006	VZ352700	Ceramic Capacitor-SL	10P 50V J			01
C3007	VV330700	Electrolytic Cap.	470.00 10.0V			01
C3008	VZ353800	Ceramic Cap.-B	470P 50V K			01
C3009	VZ352700	Ceramic Capacitor-SL	10P 50V J			01
C3010	VZ353700	Ceramic Cap.-B	330P 50V K			01
C3011	VZ353000	Ceramic Capacitor-SL	33P 50V J			01
C3012	UM417100	Electrolytic Cap.	10.00 25.0V			01
C3013	VZ597300	Mylar Capacitor	0.091 50V J			01
C3014	VZ597300	Mylar Capacitor	0.091 50V J			01
C3015	VZ353500	Ceramic Capacitor-SL	100P 50V J			01
C3016	UM417100	Electrolytic Cap.	10.00 25.0V			01
C3017	UM417100	Electrolytic Cap.	10.00 25.0V			01
C3018	VV062300	Mylar Capacitor	0.039 50V J			01
C3019	VV190000	Mylar Capacitor	820P 50V J			01
C3020	VZ353200	Ceramic Capacitor-SL	47P 50V J			01
C3021	VZ353500	Ceramic Capacitor-SL	100P 50V J			01
C3022	VV060800	Mylar Capacitor	3900P 50V J			01
C3023	VZ353500	Ceramic Capacitor-SL	100P 50V J			01
C3024	VV061400	Mylar Capacitor	0.010 50V J			01
C3025	VZ352800	Ceramic Capacitor-SL	22P 50V J			01
C3026	UJ667470	Electrolytic Cap.	47.00 25.0V			01
C3027	UM416470	Electrolytic Cap.	4.70 50.0V			01
C3028	VV062400	Mylar Capacitor	0.047 50V J			01
C3029	UM417100	Electrolytic Cap.	10.00 25.0V			01
C3030	VZ353500	Ceramic Capacitor-SL	100P 50V J			01
C3031	VZ353500	Ceramic Capacitor-SL	100P 50V J			01
C3032	VZ353200	Ceramic Capacitor-SL	47P 50V J			01
C3033	VZ354000	Ceramic Capacitor-F	0.0100 50V Z			01
C3034	VZ354000	Ceramic Capacitor-F	0.0100 50V Z			01
C3035	UJ667470	Electrolytic Cap.	47.00 25.0V			01
C3036	UM417100	Electrolytic Cap.	10.00 25.0V			01
C3037	VZ353500	Ceramic Capacitor-SL	100P 50V J			01
C3038	VZ353500	Ceramic Capacitor-SL	100P 50V J			01
C3039	VZ353200	Ceramic Capacitor-SL	47P 50V J			01
C3040	VZ354000	Ceramic Capacitor-F	0.0100 50V Z			01
C3041	VZ354000	Ceramic Capacitor-F	0.0100 50V Z			01
C3042	UJ667470	Electrolytic Cap.	47.00 25.0V			01
* CN101	V3456200	Connector	5597-NCPB 35P TE			
* -103	V3456200	Connector	5597-NCPB 35P TE			
CN107	VV067200	Connector Base Post	M2426XX 12P TE			01
CN108	VV066700	Connector Base Post	M2426XX 7P TE			01
CN109	VV067200	Connector Base Post	M2426XX 12P TE			01
CN110	VV066700	Connector Base Post	M2426XX 7P TE			01
IC101	XF195A00	IC	NJM4580L	OP AMP		04
IC102	XF195A00	IC	NJM4580L	OP AMP		04
IC103	XM356A00	IC	NJM2068L-D	OP AMP		02
-105	XM356A00	IC	NJM2068L-D	OP AMP		02
IC106	XF195A00	IC	NJM4580L	OP AMP		04
IC107	XF195A00	IC	NJM4580L	OP AMP		04
IC108	XM356A00	IC	NJM2068L-D	OP AMP		02
-110	XM356A00	IC	NJM2068L-D	OP AMP		02
IC111	XF195A00	IC	NJM4580L	OP AMP		04

*: New Parts

RANK : Japan only

REF NO.	PART NO.	DESCRIPTION		REMARKS	QTY	RANK
IC112	XF195A00	IC	NJM4580L	OP AMP		04
IC113	XM356A00	IC	NJM2068L-D	OP AMP		02
-115	XM356A00	IC	NJM2068L-D	OP AMP		02
IC116	XF195A00	IC	NJM4580L	OP AMP		04
IC117	XF195A00	IC	NJM4580L	OP AMP		04
IC118	XM356A00	IC	NJM2068L-D	OP AMP		02
-120	XM356A00	IC	NJM2068L-D	OP AMP		02
IC121	XF195A00	IC	NJM4580L	OP AMP		04
IC122	XF195A00	IC	NJM4580L	OP AMP		04
IC123	XM356A00	IC	NJM2068L-D	OP AMP		02
-125	XM356A00	IC	NJM2068L-D	OP AMP		02
IC126	XF195A00	IC	NJM4580L	OP AMP		04
IC127	XF195A00	IC	NJM4580L	OP AMP		04
IC128	XM356A00	IC	NJM2068L-D	OP AMP		02
-142	XM356A00	IC	NJM2068L-D	OP AMP		02
LD101	VV620800	LED	LT311G-41-C13 RE	PEAK(GF24/12:9ch, GF16/12:1ch)		01
LD201	VV620800	LED	LT311G-41-C13 RE	PEAK(GF24/12:10ch, GF16/12:2ch)		01
LD301	VV620800	LED	LT311G-41-C13 RE	PEAK(GF24/12:11ch, GF16/12:3ch)		01
LD401	VV620800	LED	LT311G-41-C13 RE	PEAK(GF24/12:12ch, GF16/12:4ch)		01
LD501	VV620800	LED	LT311G-41-C13 RE	PEAK(GF24/12:13ch, GF16/12:5ch)		01
LD601	VV620800	LED	LT311G-41-C13 RE	PEAK(GF24/12:14ch, GF16/12:6ch)		01
LD701	VV620800	LED	LT311G-41-C13 RE	PEAK(GF24/12:15ch, GF16/12:7ch)		01
LD801	VV620800	LED	LT311G-41-C13 RE	PEAK(GF24/12:16ch, GF16/12:8ch)		01
LD901	VV620800	LED	LT311G-41-C13 RE	PEAK(GF24/12:17-20ch, GF16/12:9-12ch)		01
-904	VV620800	LED	LT311G-41-C13 RE			01
Q101	IC224030	Transistor	2SC2240 GR,BL			01
Q102	IC224030	Transistor	2SC2240 GR,BL			01
Q103	IA101590	Transistor	2SA1015 O,Y			01
Q104	IC1815M0	Transistor	2SC1815 Y,GR			01
Q201	IC224030	Transistor	2SC2240 GR,BL			01
Q202	IC224030	Transistor	2SC2240 GR,BL			01
Q203	IA101590	Transistor	2SA1015 O,Y			01
Q204	IC1815M0	Transistor	2SC1815 Y,GR			01
Q301	IC224030	Transistor	2SC2240 GR,BL			01
Q302	IC224030	Transistor	2SC2240 GR,BL			01
Q303	IA101590	Transistor	2SA1015 O,Y			01
Q304	IC1815M0	Transistor	2SC1815 Y,GR			01
Q401	IC224030	Transistor	2SC2240 GR,BL			01
Q402	IC224030	Transistor	2SC2240 GR,BL			01
Q403	IA101590	Transistor	2SA1015 O,Y			01
Q404	IC1815M0	Transistor	2SC1815 Y,GR			01
Q501	IC224030	Transistor	2SC2240 GR,BL			01
Q502	IC224030	Transistor	2SC2240 GR,BL			01
Q503	IA101590	Transistor	2SA1015 O,Y			01
Q504	IC1815M0	Transistor	2SC1815 Y,GR			01
Q601	IC224030	Transistor	2SC2240 GR,BL			01
Q602	IC224030	Transistor	2SC2240 GR,BL			01
Q603	IA101590	Transistor	2SA1015 O,Y			01
Q604	IC1815M0	Transistor	2SC1815 Y,GR			01
Q701	IC224030	Transistor	2SC2240 GR,BL			01
Q702	IC224030	Transistor	2SC2240 GR,BL			01
Q703	IA101590	Transistor	2SA1015 O,Y			01
Q704	IC1815M0	Transistor	2SC1815 Y,GR			01
Q801	IC224030	Transistor	2SC2240 GR,BL			01
Q802	IC224030	Transistor	2SC2240 GR,BL			01
Q803	IA101590	Transistor	2SA1015 O,Y			01
Q804	IC1815M0	Transistor	2SC1815 Y,GR			01
Q901	IC224030	Transistor	2SC2240 GR,BL			01
Q902	IC224030	Transistor	2SC2240 GR,BL			01
Q903	IA101590	Transistor	2SA1015 O,Y			01
Q904	IC1815M0	Transistor	2SC1815 Y,GR			01
Q1001	IC224030	Transistor	2SC2240 GR,BL			01

* : New Parts

RANK : Japan only

REF NO.	PART NO.	DESCRIPTION	REMARKS	QTY	RANK
Q1002	IC224030	Transistor	2SC2240 GR,BL		01
Q1003	IA101590	Transistor	2SA1015 O,Y		01
Q1004	IC1815M0	Transistor	2SC1815 Y,GR		01
Q2001	IC224030	Transistor	2SC2240 GR,BL		01
Q2002	IC224030	Transistor	2SC2240 GR,BL		01
Q2003	IA101590	Transistor	2SA1015 O,Y		01
Q2004	IC1815M0	Transistor	2SC1815 Y,GR		01
Q3001	IC224030	Transistor	2SC2240 GR,BL		01
Q3002	IC224030	Transistor	2SC2240 GR,BL		01
Q3003	IA101590	Transistor	2SA1015 O,Y		01
Q3004	IC1815M0	Transistor	2SC1815 Y,GR		01
R101	VV065200	Metal Film Resistor	4.7K 1/4 F		05
R102	VZ598300	Metal Film Resistor	510.0 1/4 F		01
R103	VV065200	Metal Film Resistor	4.7K 1/4 F		05
-105	VV065200	Metal Film Resistor	4.7K 1/4 F		05
R106	HF454100	Carbon Resistor	10.0 1/4 J		01
R107	HF454100	Carbon Resistor	10.0 1/4 J		01
R108	VV066100	Metal Film Resistor	47K 1/4 F		01
R109	VV066100	Metal Film Resistor	47K 1/4 F		01
R110	HF454100	Carbon Resistor	10.0 1/4 J		01
R111	VV065100	Metal Film Resistor	2.2K 1/4 F		01
R112	VV065400	Metal Film Resistor	8.2K 1/4 F		01
R113	VV064900	Metal Film Resistor	20.0 1/4 F		01
R114	VV065900	Metal Film Resistor	24K 1/4 F		01
R115	VV065100	Metal Film Resistor	2.2K 1/4 F		01
R116	VV065400	Metal Film Resistor	8.2K 1/4 F		01
R117	VV065900	Metal Film Resistor	24K 1/4 F		01
R118	HF454100	Carbon Resistor	10.0 1/4 J		01
R119	VV065200	Metal Film Resistor	4.7K 1/4 F		05
R120	VV065200	Metal Film Resistor	4.7K 1/4 F		05
R121	HF458220	Carbon Resistor	220.0K 1/4 J		01
R122	HF457150	Carbon Resistor	15.0K 1/4 J		01
R123	HF457300	Carbon Resistor	30.0K 1/4 J		01
R124	HF454100	Carbon Resistor	10.0 1/4 J		01
R125	HF458220	Carbon Resistor	220.0K 1/4 J		01
R126	HF458220	Carbon Resistor	220.0K 1/4 J		01
R127	HF457100	Carbon Resistor	10.0K 1/4 J		01
R128	HF456470	Carbon Resistor	4.7K 1/4 J		01
R129	HF457330	Carbon Resistor	33.0K 1/4 J		01
R130	HF457100	Carbon Resistor	10.0K 1/4 J		01
R131	HF856560	Carbon Resistor	5.6K 1/4 J		01
R132	HF456470	Carbon Resistor	4.7K 1/4 J		01
R133	HF456820	Carbon Resistor	8.2K 1/4 J		01
R134	HF456470	Carbon Resistor	4.7K 1/4 J		01
R135	HF456820	Carbon Resistor	8.2K 1/4 J		01
R136	HF454100	Carbon Resistor	10.0 1/4 J		01
R137	HF458220	Carbon Resistor	220.0K 1/4 J		01
R138	HF858100	Carbon Resistor	100.0K 1/4 J		01
R139	HF456820	Carbon Resistor	8.2K 1/4 J		01
R140	HF858100	Carbon Resistor	100.0K 1/4 J		01
R141	HF456470	Carbon Resistor	4.7K 1/4 J		01
R142	HF858100	Carbon Resistor	100.0K 1/4 J		01
R143	HF456330	Carbon Resistor	3.3K 1/4 J		01
R144	HF456510	Carbon Resistor	5.1K 1/4 J		01
R145	HF456510	Carbon Resistor	5.1K 1/4 J		01
R146	HF454220	Carbon Resistor	22.0 1/4 J		01
R147	HF456510	Carbon Resistor	5.1K 1/4 J		01
R148	HF456510	Carbon Resistor	5.1K 1/4 J		01
R149	HF454220	Carbon Resistor	22.0 1/4 J		01
R150	HF455220	Carbon Resistor	220.0 1/4 J		01
R151	HF457180	Carbon Resistor	18.0K 1/4 J		01
R152	HF455220	Carbon Resistor	220.0 1/4 J		01
R153	HF456470	Carbon Resistor	4.7K 1/4 J		01
R154	HF457100	Carbon Resistor	10.0K 1/4 J		01
R155	HF454100	Carbon Resistor	10.0 1/4 J		01
R156	HF458220	Carbon Resistor	220.0K 1/4 J		01
R157	HF457180	Carbon Resistor	18.0K 1/4 J		01
-170	HF457180	Carbon Resistor	18.0K 1/4 J		01
R201	VV065200	Metal Film Resistor	4.7K 1/4 F		05
R202	VZ598300	Metal Film Resistor	510.0 1/4 F		01

*: New Parts

RANK : Japan only

GF24/12
GF16/12
GF12/12

REF NO.	PART NO.	DESCRIPTION		REMARKS	QTY	RANK
R203	VV065200	Metal Film Resistor	4.7K 1/4 F			05
-205	VV065200	Metal Film Resistor	4.7K 1/4 F			05
R206	HF454100	Carbon Resistor	10.0 1/4 J			01
R207	HF454100	Carbon Resistor	10.0 1/4 J			01
R208	VV066100	Metal Film Resistor	47K 1/4 F			01
R209	VV066100	Metal Film Resistor	47K 1/4 F			01
R210	HF454100	Carbon Resistor	10.0 1/4 J			01
R211	VV065100	Metal Film Resistor	2.2K 1/4 F			01
R212	VV065400	Metal Film Resistor	8.2K 1/4 F			01
R213	VV064900	Metal Film Resistor	20.0 1/4 F			01
R214	VV065900	Metal Film Resistor	24K 1/4 F			01
R215	VV065100	Metal Film Resistor	2.2K 1/4 F			01
R216	VV065400	Metal Film Resistor	8.2K 1/4 F			01
R217	VV065900	Metal Film Resistor	24K 1/4 F			01
R218	HF454100	Carbon Resistor	10.0 1/4 J			01
R219	VV065200	Metal Film Resistor	4.7K 1/4 F			05
R220	VV065200	Metal Film Resistor	4.7K 1/4 F			05
R221	HF458220	Carbon Resistor	220.0K 1/4 J			01
R222	HF457150	Carbon Resistor	15.0K 1/4 J			01
R223	HF457300	Carbon Resistor	30.0K 1/4 J			01
R224	HF454100	Carbon Resistor	10.0 1/4 J			01
R225	HF458220	Carbon Resistor	220.0K 1/4 J			01
R226	HF458220	Carbon Resistor	220.0K 1/4 J			01
R227	HF457100	Carbon Resistor	10.0K 1/4 J			01
R228	HF456470	Carbon Resistor	4.7K 1/4 J			01
R229	HF457330	Carbon Resistor	33.0K 1/4 J			01
R230	HF457100	Carbon Resistor	10.0K 1/4 J			01
R231	HF856560	Carbon Resistor	5.6K 1/4 J			01
R232	HF456470	Carbon Resistor	4.7K 1/4 J			01
R233	HF456820	Carbon Resistor	8.2K 1/4 J			01
R234	HF456470	Carbon Resistor	4.7K 1/4 J			01
R235	HF456820	Carbon Resistor	8.2K 1/4 J			01
R236	HF454100	Carbon Resistor	10.0 1/4 J			01
R237	HF458220	Carbon Resistor	220.0K 1/4 J			01
R238	HF858100	Carbon Resistor	100.0K 1/4 J			01
R239	HF456820	Carbon Resistor	8.2K 1/4 J			01
R240	HF858100	Carbon Resistor	100.0K 1/4 J			01
R241	HF456470	Carbon Resistor	4.7K 1/4 J			01
R242	HF858100	Carbon Resistor	100.0K 1/4 J			01
R243	HF456330	Carbon Resistor	3.3K 1/4 J			01
R244	HF456510	Carbon Resistor	5.1K 1/4 J			01
R245	HF456510	Carbon Resistor	5.1K 1/4 J			01
R246	HF454220	Carbon Resistor	22.0 1/4 J			01
R247	HF456510	Carbon Resistor	5.1K 1/4 J			01
R248	HF456510	Carbon Resistor	5.1K 1/4 J			01
R249	HF454220	Carbon Resistor	22.0 1/4 J			01
R250	HF455220	Carbon Resistor	220.0 1/4 J			01
R251	HF457180	Carbon Resistor	18.0K 1/4 J			01
R252	HF455220	Carbon Resistor	220.0 1/4 J			01
R253	HF456470	Carbon Resistor	4.7K 1/4 J			01
R254	HF457100	Carbon Resistor	10.0K 1/4 J			01
R255	HF454100	Carbon Resistor	10.0 1/4 J			01
R256	HF458220	Carbon Resistor	220.0K 1/4 J			01
R257	HF457180	Carbon Resistor	18.0K 1/4 J			01
-270	HF457180	Carbon Resistor	18.0K 1/4 J			01
R301	VV065200	Metal Film Resistor	4.7K 1/4 F			05
R302	VZ598300	Metal Film Resistor	510.0 1/4 F			01
R303	VV065200	Metal Film Resistor	4.7K 1/4 F			05
-305	VV065200	Metal Film Resistor	4.7K 1/4 F			05
R306	HF454100	Carbon Resistor	10.0 1/4 J			01
R307	HF454100	Carbon Resistor	10.0 1/4 J			01
R308	VV066100	Metal Film Resistor	47K 1/4 F			01
R309	VV066100	Metal Film Resistor	47K 1/4 F			01
R310	HF454100	Carbon Resistor	10.0 1/4 J			01
R311	VV065100	Metal Film Resistor	2.2K 1/4 F			01
R312	VV065400	Metal Film Resistor	8.2K 1/4 F			01
R313	VV064900	Metal Film Resistor	20.0 1/4 F			01
R314	VV065900	Metal Film Resistor	24K 1/4 F			01
R315	VV065100	Metal Film Resistor	2.2K 1/4 F			01
R316	VV065400	Metal Film Resistor	8.2K 1/4 F			01

* : New Parts

RANK : Japan only

REF NO.	PART NO.	DESCRIPTION	REMARKS	QTY	RANK
R317	VV065900	Metal Film Resistor	24K 1/4 F		01
R318	HF454100	Carbon Resistor	10.0 1/4 J		01
R319	VV065200	Metal Film Resistor	4.7K 1/4 F		05
R320	VV065200	Metal Film Resistor	4.7K 1/4 F		05
R321	HF458220	Carbon Resistor	220.0K 1/4 J		01
R322	HF457150	Carbon Resistor	15.0K 1/4 J		01
R323	HF457300	Carbon Resistor	30.0K 1/4 J		01
R324	HF454100	Carbon Resistor	10.0 1/4 J		01
R325	HF458220	Carbon Resistor	220.0K 1/4 J		01
R326	HF458220	Carbon Resistor	220.0K 1/4 J		01
R327	HF457100	Carbon Resistor	10.0K 1/4 J		01
R328	HF456470	Carbon Resistor	4.7K 1/4 J		01
R329	HF457330	Carbon Resistor	33.0K 1/4 J		01
R330	HF457100	Carbon Resistor	10.0K 1/4 J		01
R331	HF856560	Carbon Resistor	5.6K 1/4 J		01
R332	HF456470	Carbon Resistor	4.7K 1/4 J		01
R333	HF456820	Carbon Resistor	8.2K 1/4 J		01
R334	HF456470	Carbon Resistor	4.7K 1/4 J		01
R335	HF456820	Carbon Resistor	8.2K 1/4 J		01
R336	HF454100	Carbon Resistor	10.0 1/4 J		01
R337	HF458220	Carbon Resistor	220.0K 1/4 J		01
R338	HF858100	Carbon Resistor	100.0K 1/4 J		01
R339	HF456820	Carbon Resistor	8.2K 1/4 J		01
R340	HF858100	Carbon Resistor	100.0K 1/4 J		01
R341	HF456470	Carbon Resistor	4.7K 1/4 J		01
R342	HF858100	Carbon Resistor	100.0K 1/4 J		01
R343	HF456330	Carbon Resistor	3.3K 1/4 J		01
R344	HF456510	Carbon Resistor	5.1K 1/4 J		01
R345	HF456510	Carbon Resistor	5.1K 1/4 J		01
R346	HF454220	Carbon Resistor	22.0 1/4 J		01
R347	HF456510	Carbon Resistor	5.1K 1/4 J		01
R348	HF456510	Carbon Resistor	5.1K 1/4 J		01
R349	HF454220	Carbon Resistor	22.0 1/4 J		01
R350	HF455220	Carbon Resistor	220.0 1/4 J		01
R351	HF457180	Carbon Resistor	18.0K 1/4 J		01
R352	HF455220	Carbon Resistor	220.0 1/4 J		01
R353	HF456470	Carbon Resistor	4.7K 1/4 J		01
R354	HF457100	Carbon Resistor	10.0K 1/4 J		01
R355	HF454100	Carbon Resistor	10.0 1/4 J		01
R356	HF458220	Carbon Resistor	220.0K 1/4 J		01
R357	HF457180	Carbon Resistor	18.0K 1/4 J		01
-370	HF457180	Carbon Resistor	18.0K 1/4 J		01
R401	VV065200	Metal Film Resistor	4.7K 1/4 F		05
R402	VZ598300	Metal Film Resistor	510.0 1/4 F		01
R403	VV065200	Metal Film Resistor	4.7K 1/4 F		05
-405	VV065200	Metal Film Resistor	4.7K 1/4 F		05
R406	HF454100	Carbon Resistor	10.0 1/4 J		01
R407	HF454100	Carbon Resistor	10.0 1/4 J		01
R408	VV066100	Metal Film Resistor	47K 1/4 F		01
R409	VV066100	Metal Film Resistor	47K 1/4 F		01
R410	HF454100	Carbon Resistor	10.0 1/4 J		01
R411	VV065100	Metal Film Resistor	2.2K 1/4 F		01
R412	VV065400	Metal Film Resistor	8.2K 1/4 F		01
R413	VV064900	Metal Film Resistor	20.0 1/4 F		01
R414	VV065900	Metal Film Resistor	24K 1/4 F		01
R415	VV065100	Metal Film Resistor	2.2K 1/4 F		01
R416	VV065400	Metal Film Resistor	8.2K 1/4 F		01
R417	VV065900	Metal Film Resistor	24K 1/4 F		01
R418	HF454100	Carbon Resistor	10.0 1/4 J		01
R419	VV065200	Metal Film Resistor	4.7K 1/4 F		05
R420	VV065200	Metal Film Resistor	4.7K 1/4 F		05
R421	HF458220	Carbon Resistor	220.0K 1/4 J		01
R422	HF457150	Carbon Resistor	15.0K 1/4 J		01
R423	HF457300	Carbon Resistor	30.0K 1/4 J		01
R424	HF454100	Carbon Resistor	10.0 1/4 J		01
R425	HF458220	Carbon Resistor	220.0K 1/4 J		01
R426	HF458220	Carbon Resistor	220.0K 1/4 J		01
R427	HF457100	Carbon Resistor	10.0K 1/4 J		01
R428	HF456470	Carbon Resistor	4.7K 1/4 J		01
R429	HF457330	Carbon Resistor	33.0K 1/4 J		01

*: New Parts

RANK : Japan only

REF NO.	PART NO.	DESCRIPTION		REMARKS	QTY	RANK
R430	HF457100	Carbon Resistor	10.0K 1/4 J			01
R431	HF856560	Carbon Resistor	5.6K 1/4 J			01
R432	HF456470	Carbon Resistor	4.7K 1/4 J			01
R433	HF456820	Carbon Resistor	8.2K 1/4 J			01
R434	HF456470	Carbon Resistor	4.7K 1/4 J			01
R435	HF456820	Carbon Resistor	8.2K 1/4 J			01
R436	HF454100	Carbon Resistor	10.0 1/4 J			01
R437	HF458220	Carbon Resistor	220.0K 1/4 J			01
R438	HF858100	Carbon Resistor	100.0K 1/4 J			01
R439	HF456820	Carbon Resistor	8.2K 1/4 J			01
R440	HF858100	Carbon Resistor	100.0K 1/4 J			01
R441	HF456470	Carbon Resistor	4.7K 1/4 J			01
R442	HF858100	Carbon Resistor	100.0K 1/4 J			01
R443	HF456330	Carbon Resistor	3.3K 1/4 J			01
R444	HF456510	Carbon Resistor	5.1K 1/4 J			01
R445	HF456510	Carbon Resistor	5.1K 1/4 J			01
R446	HF454220	Carbon Resistor	22.0 1/4 J			01
R447	HF456510	Carbon Resistor	5.1K 1/4 J			01
R448	HF456510	Carbon Resistor	5.1K 1/4 J			01
R449	HF454220	Carbon Resistor	22.0 1/4 J			01
R450	HF455220	Carbon Resistor	220.0 1/4 J			01
R451	HF457180	Carbon Resistor	18.0K 1/4 J			01
R452	HF455220	Carbon Resistor	220.0 1/4 J			01
R453	HF456470	Carbon Resistor	4.7K 1/4 J			01
R454	HF457100	Carbon Resistor	10.0K 1/4 J			01
R455	HF454100	Carbon Resistor	10.0 1/4 J			01
R456	HF458220	Carbon Resistor	220.0K 1/4 J			01
R457	HF457180	Carbon Resistor	18.0K 1/4 J			01
-470	HF457180	Carbon Resistor	18.0K 1/4 J			01
R501	VV065200	Metal Film Resistor	4.7K 1/4 F			05
R502	VZ598300	Metal Film Resistor	510.0 1/4 F			01
R503	VV065200	Metal Film Resistor	4.7K 1/4 F			05
-505	VV065200	Metal Film Resistor	4.7K 1/4 F			05
R506	HF454100	Carbon Resistor	10.0 1/4 J			01
R507	HF454100	Carbon Resistor	10.0 1/4 J			01
R508	VV066100	Metal Film Resistor	47K 1/4 F			01
R509	VV066100	Metal Film Resistor	47K 1/4 F			01
R510	HF454100	Carbon Resistor	10.0 1/4 J			01
R511	VV065100	Metal Film Resistor	2.2K 1/4 F			01
R512	VV065400	Metal Film Resistor	8.2K 1/4 F			01
R513	VV064900	Metal Film Resistor	20.0 1/4 F			01
R514	VV065900	Metal Film Resistor	24K 1/4 F			01
R515	VV065100	Metal Film Resistor	2.2K 1/4 F			01
R516	VV065400	Metal Film Resistor	8.2K 1/4 F			01
R517	VV065900	Metal Film Resistor	24K 1/4 F			01
R518	HF454100	Carbon Resistor	10.0 1/4 J			01
R519	VV065200	Metal Film Resistor	4.7K 1/4 F			05
R520	VV065200	Metal Film Resistor	4.7K 1/4 F			05
R521	HF458220	Carbon Resistor	220.0K 1/4 J			01
R522	HF457150	Carbon Resistor	15.0K 1/4 J			01
R523	HF457300	Carbon Resistor	30.0K 1/4 J			01
R524	HF454100	Carbon Resistor	10.0 1/4 J			01
R525	HF458220	Carbon Resistor	220.0K 1/4 J			01
R526	HF458220	Carbon Resistor	220.0K 1/4 J			01
R527	HF457100	Carbon Resistor	10.0K 1/4 J			01
R528	HF456470	Carbon Resistor	4.7K 1/4 J			01
R529	HF457330	Carbon Resistor	33.0K 1/4 J			01
R530	HF457100	Carbon Resistor	10.0K 1/4 J			01
R531	HF856560	Carbon Resistor	5.6K 1/4 J			01
R532	HF456470	Carbon Resistor	4.7K 1/4 J			01
R533	HF456820	Carbon Resistor	8.2K 1/4 J			01
R534	HF456470	Carbon Resistor	4.7K 1/4 J			01
R535	HF456820	Carbon Resistor	8.2K 1/4 J			01
R536	HF454100	Carbon Resistor	10.0 1/4 J			01
R537	HF458220	Carbon Resistor	220.0K 1/4 J			01
R538	HF858100	Carbon Resistor	100.0K 1/4 J			01
R539	HF456820	Carbon Resistor	8.2K 1/4 J			01
R540	HF858100	Carbon Resistor	100.0K 1/4 J			01
R541	HF456470	Carbon Resistor	4.7K 1/4 J			01
R542	HF858100	Carbon Resistor	100.0K 1/4 J			01

* : New Parts

RANK : Japan only

REF NO.	PART NO.	DESCRIPTION		REMARKS	QTY	RANK
R543	HF456330	Carbon Resistor	3.3K 1/4 J			01
R544	HF456510	Carbon Resistor	5.1K 1/4 J			01
R545	HF456510	Carbon Resistor	5.1K 1/4 J			01
R546	HF454220	Carbon Resistor	22.0 1/4 J			01
R547	HF456510	Carbon Resistor	5.1K 1/4 J			01
R548	HF456510	Carbon Resistor	5.1K 1/4 J			01
R549	HF454220	Carbon Resistor	22.0 1/4 J			01
R550	HF455220	Carbon Resistor	220.0 1/4 J			01
R551	HF457180	Carbon Resistor	18.0K 1/4 J			01
R552	HF455220	Carbon Resistor	220.0 1/4 J			01
R553	HF456470	Carbon Resistor	4.7K 1/4 J			01
R554	HF457100	Carbon Resistor	10.0K 1/4 J			01
R555	HF454100	Carbon Resistor	10.0 1/4 J			01
R556	HF458220	Carbon Resistor	220.0K 1/4 J			01
R557	HF457180	Carbon Resistor	18.0K 1/4 J			01
-570	HF457180	Carbon Resistor	18.0K 1/4 J			01
R601	VV065200	Metal Film Resistor	4.7K 1/4 F			05
R602	VZ598300	Metal Film Resistor	510.0 1/4 F			01
R603	VV065200	Metal Film Resistor	4.7K 1/4 F			05
-605	VV065200	Metal Film Resistor	4.7K 1/4 F			05
R606	HF454100	Carbon Resistor	10.0 1/4 J			01
R607	HF454100	Carbon Resistor	10.0 1/4 J			01
R608	VV066100	Metal Film Resistor	47K 1/4 F			01
R609	VV066100	Metal Film Resistor	47K 1/4 F			01
R610	HF454100	Carbon Resistor	10.0 1/4 J			01
R611	VV065100	Metal Film Resistor	2.2K 1/4 F			01
R612	VV065400	Metal Film Resistor	8.2K 1/4 F			01
R613	VV064900	Metal Film Resistor	20.0 1/4 F			01
R614	VV065900	Metal Film Resistor	24K 1/4 F			01
R615	VV065100	Metal Film Resistor	2.2K 1/4 F			01
R616	VV065400	Metal Film Resistor	8.2K 1/4 F			01
R617	VV065900	Metal Film Resistor	24K 1/4 F			01
R618	HF454100	Carbon Resistor	10.0 1/4 J			01
R619	VV065200	Metal Film Resistor	4.7K 1/4 F			05
R620	VV065200	Metal Film Resistor	4.7K 1/4 F			05
R621	HF458220	Carbon Resistor	220.0K 1/4 J			01
R622	HF457150	Carbon Resistor	15.0K 1/4 J			01
R623	HF457300	Carbon Resistor	30.0K 1/4 J			01
R624	HF454100	Carbon Resistor	10.0 1/4 J			01
R625	HF458220	Carbon Resistor	220.0K 1/4 J			01
R626	HF458220	Carbon Resistor	220.0K 1/4 J			01
R627	HF457100	Carbon Resistor	10.0K 1/4 J			01
R628	HF456470	Carbon Resistor	4.7K 1/4 J			01
R629	HF457330	Carbon Resistor	33.0K 1/4 J			01
R630	HF457100	Carbon Resistor	10.0K 1/4 J			01
R631	HF856560	Carbon Resistor	5.6K 1/4 J			01
R632	HF456470	Carbon Resistor	4.7K 1/4 J			01
R633	HF456820	Carbon Resistor	8.2K 1/4 J			01
R634	HF456470	Carbon Resistor	4.7K 1/4 J			01
R635	HF456820	Carbon Resistor	8.2K 1/4 J			01
R636	HF454100	Carbon Resistor	10.0 1/4 J			01
R637	HF458220	Carbon Resistor	220.0K 1/4 J			01
R638	HF858100	Carbon Resistor	100.0K 1/4 J			01
R639	HF456820	Carbon Resistor	8.2K 1/4 J			01
R640	HF858100	Carbon Resistor	100.0K 1/4 J			01
R641	HF456470	Carbon Resistor	4.7K 1/4 J			01
R642	HF858100	Carbon Resistor	100.0K 1/4 J			01
R643	HF456330	Carbon Resistor	3.3K 1/4 J			01
R644	HF456510	Carbon Resistor	5.1K 1/4 J			01
R645	HF456510	Carbon Resistor	5.1K 1/4 J			01
R646	HF454220	Carbon Resistor	22.0 1/4 J			01
R647	HF456510	Carbon Resistor	5.1K 1/4 J			01
R648	HF456510	Carbon Resistor	5.1K 1/4 J			01
R649	HF454220	Carbon Resistor	22.0 1/4 J			01
R650	HF455220	Carbon Resistor	220.0 1/4 J			01
R651	HF457180	Carbon Resistor	18.0K 1/4 J			01
R652	HF455220	Carbon Resistor	220.0 1/4 J			01
R653	HF456470	Carbon Resistor	4.7K 1/4 J			01
R654	HF457100	Carbon Resistor	10.0K 1/4 J			01
R655	HF454100	Carbon Resistor	10.0 1/4 J			01

*: New Parts

RANK : Japan only

REF NO.	PART NO.	DESCRIPTION		REMARKS	QTY	RANK
R656	HF458220	Carbon Resistor	220.0K 1/4 J			01
R657	HF457180	Carbon Resistor	18.0K 1/4 J			01
-670	HF457180	Carbon Resistor	18.0K 1/4 J			01
R701	VV065200	Metal Film Resistor	4.7K 1/4 F			05
R702	VZ598300	Metal Film Resistor	510.0 1/4 F			01
R703	VV065200	Metal Film Resistor	4.7K 1/4 F			05
-705	VV065200	Metal Film Resistor	4.7K 1/4 F			05
R706	HF454100	Carbon Resistor	10.0 1/4 J			01
R707	HF454100	Carbon Resistor	10.0 1/4 J			01
R708	VV066100	Metal Film Resistor	47K 1/4 F			01
R709	VV066100	Metal Film Resistor	47K 1/4 F			01
R710	HF454100	Carbon Resistor	10.0 1/4 J			01
R711	VV065100	Metal Film Resistor	2.2K 1/4 F			01
R712	VV065400	Metal Film Resistor	8.2K 1/4 F			01
R713	VV064900	Metal Film Resistor	20.0 1/4 F			01
R714	VV065900	Metal Film Resistor	24K 1/4 F			01
R715	VV065100	Metal Film Resistor	2.2K 1/4 F			01
R716	VV065400	Metal Film Resistor	8.2K 1/4 F			01
R717	VV065900	Metal Film Resistor	24K 1/4 F			01
R718	HF454100	Carbon Resistor	10.0 1/4 J			01
R719	VV065200	Metal Film Resistor	4.7K 1/4 F			05
R720	VV065200	Metal Film Resistor	4.7K 1/4 F			05
R721	HF458220	Carbon Resistor	220.0K 1/4 J			01
R722	HF457150	Carbon Resistor	15.0K 1/4 J			01
R723	HF457300	Carbon Resistor	30.0K 1/4 J			01
R724	HF454100	Carbon Resistor	10.0 1/4 J			01
R725	HF458220	Carbon Resistor	220.0K 1/4 J			01
R726	HF458220	Carbon Resistor	220.0K 1/4 J			01
R727	HF457100	Carbon Resistor	10.0K 1/4 J			01
R728	HF456470	Carbon Resistor	4.7K 1/4 J			01
R729	HF457330	Carbon Resistor	33.0K 1/4 J			01
R730	HF457100	Carbon Resistor	10.0K 1/4 J			01
R731	HF856560	Carbon Resistor	5.6K 1/4 J			01
R732	HF456470	Carbon Resistor	4.7K 1/4 J			01
R733	HF456820	Carbon Resistor	8.2K 1/4 J			01
R734	HF456470	Carbon Resistor	4.7K 1/4 J			01
R735	HF456820	Carbon Resistor	8.2K 1/4 J			01
R736	HF454100	Carbon Resistor	10.0 1/4 J			01
R737	HF458220	Carbon Resistor	220.0K 1/4 J			01
R738	HF858100	Carbon Resistor	100.0K 1/4 J			01
R739	HF456820	Carbon Resistor	8.2K 1/4 J			01
R740	HF858100	Carbon Resistor	100.0K 1/4 J			01
R741	HF456470	Carbon Resistor	4.7K 1/4 J			01
R742	HF858100	Carbon Resistor	100.0K 1/4 J			01
R743	HF456330	Carbon Resistor	3.3K 1/4 J			01
R744	HF456510	Carbon Resistor	5.1K 1/4 J			01
R745	HF456510	Carbon Resistor	5.1K 1/4 J			01
R746	HF454220	Carbon Resistor	22.0 1/4 J			01
R747	HF456510	Carbon Resistor	5.1K 1/4 J			01
R748	HF456510	Carbon Resistor	5.1K 1/4 J			01
R749	HF454220	Carbon Resistor	22.0 1/4 J			01
R750	HF455220	Carbon Resistor	220.0 1/4 J			01
R751	HF457180	Carbon Resistor	18.0K 1/4 J			01
R752	HF455220	Carbon Resistor	220.0 1/4 J			01
R753	HF456470	Carbon Resistor	4.7K 1/4 J			01
R754	HF457100	Carbon Resistor	10.0K 1/4 J			01
R755	HF454100	Carbon Resistor	10.0 1/4 J			01
R756	HF458220	Carbon Resistor	220.0K 1/4 J			01
R757	HF457180	Carbon Resistor	18.0K 1/4 J			01
-770	HF457180	Carbon Resistor	18.0K 1/4 J			01
R801	VV065200	Metal Film Resistor	4.7K 1/4 F			05
R802	VZ598300	Metal Film Resistor	510.0 1/4 F			01
R803	VV065200	Metal Film Resistor	4.7K 1/4 F			05
-805	VV065200	Metal Film Resistor	4.7K 1/4 F			05
R806	HF454100	Carbon Resistor	10.0 1/4 J			01
R807	HF454100	Carbon Resistor	10.0 1/4 J			01
R808	VV066100	Metal Film Resistor	47K 1/4 F			01
R809	VV066100	Metal Film Resistor	47K 1/4 F			01
R810	HF454100	Carbon Resistor	10.0 1/4 J			01
R811	VV065100	Metal Film Resistor	2.2K 1/4 F			01

* : New Parts

RANK : Japan only

REF NO.	PART NO.	DESCRIPTION	REMARKS	QTY	RANK
R812	VV065400	Metal Film Resistor	8.2K 1/4 F		01
R813	VV064900	Metal Film Resistor	20.0 1/4 F		01
R814	VV065900	Metal Film Resistor	24K 1/4 F		01
R815	VV065100	Metal Film Resistor	2.2K 1/4 F		01
R816	VV065400	Metal Film Resistor	8.2K 1/4 F		01
R817	VV065900	Metal Film Resistor	24K 1/4 F		01
R818	HF454100	Carbon Resistor	10.0 1/4 J		01
R819	VV065200	Metal Film Resistor	4.7K 1/4 F		05
R820	VV065200	Metal Film Resistor	4.7K 1/4 F		05
R821	HF458220	Carbon Resistor	220.0K 1/4 J		01
R822	HF457150	Carbon Resistor	15.0K 1/4 J		01
R823	HF457300	Carbon Resistor	30.0K 1/4 J		01
R824	HF454100	Carbon Resistor	10.0 1/4 J		01
R825	HF458220	Carbon Resistor	220.0K 1/4 J		01
R826	HF458220	Carbon Resistor	220.0K 1/4 J		01
R827	HF457100	Carbon Resistor	10.0K 1/4 J		01
R828	HF456470	Carbon Resistor	4.7K 1/4 J		01
R829	HF457330	Carbon Resistor	33.0K 1/4 J		01
R830	HF457100	Carbon Resistor	10.0K 1/4 J		01
R831	HF856560	Carbon Resistor	5.6K 1/4 J		01
R832	HF456470	Carbon Resistor	4.7K 1/4 J		01
R833	HF456820	Carbon Resistor	8.2K 1/4 J		01
R834	HF456470	Carbon Resistor	4.7K 1/4 J		01
R835	HF456820	Carbon Resistor	8.2K 1/4 J		01
R836	HF454100	Carbon Resistor	10.0 1/4 J		01
R837	HF458220	Carbon Resistor	220.0K 1/4 J		01
R838	HF858100	Carbon Resistor	100.0K 1/4 J		01
R839	HF456820	Carbon Resistor	8.2K 1/4 J		01
R840	HF858100	Carbon Resistor	100.0K 1/4 J		01
R841	HF456470	Carbon Resistor	4.7K 1/4 J		01
R842	HF858100	Carbon Resistor	100.0K 1/4 J		01
R843	HF456330	Carbon Resistor	3.3K 1/4 J		01
R844	HF456510	Carbon Resistor	5.1K 1/4 J		01
R845	HF456510	Carbon Resistor	5.1K 1/4 J		01
R846	HF454220	Carbon Resistor	22.0 1/4 J		01
R847	HF456510	Carbon Resistor	5.1K 1/4 J		01
R848	HF456510	Carbon Resistor	5.1K 1/4 J		01
R849	HF454220	Carbon Resistor	22.0 1/4 J		01
R850	HF455220	Carbon Resistor	220.0 1/4 J		01
R851	HF457180	Carbon Resistor	18.0K 1/4 J		01
R852	HF455220	Carbon Resistor	220.0 1/4 J		01
R853	HF456470	Carbon Resistor	4.7K 1/4 J		01
R854	HF457100	Carbon Resistor	10.0K 1/4 J		01
R855	HF454100	Carbon Resistor	10.0 1/4 J		01
R856	HF458220	Carbon Resistor	220.0K 1/4 J		01
R857	HF457180	Carbon Resistor	18.0K 1/4 J		01
-870	HF457180	Carbon Resistor	18.0K 1/4 J		01
R901	VV065200	Metal Film Resistor	4.7K 1/4 F		05
R902	VZ598300	Metal Film Resistor	510.0 1/4 F		01
R903	VV065200	Metal Film Resistor	4.7K 1/4 F		05
-905	VV065200	Metal Film Resistor	4.7K 1/4 F		05
R906	HF454100	Carbon Resistor	10.0 1/4 J		01
R907	HF454100	Carbon Resistor	10.0 1/4 J		01
R908	VV066100	Metal Film Resistor	47K 1/4 F		01
R909	VV066100	Metal Film Resistor	47K 1/4 F		01
R910	HF454100	Carbon Resistor	10.0 1/4 J		01
R911	VV065100	Metal Film Resistor	2.2K 1/4 F		01
R912	VV065400	Metal Film Resistor	8.2K 1/4 F		01
R913	VV064900	Metal Film Resistor	20.0 1/4 F		01
R914	VV065900	Metal Film Resistor	24K 1/4 F		01
R915	VV065100	Metal Film Resistor	2.2K 1/4 F		01
R916	VV065400	Metal Film Resistor	8.2K 1/4 F		01
R917	VV065900	Metal Film Resistor	24K 1/4 F		01
R918	HF454100	Carbon Resistor	10.0 1/4 J		01
R919	VV065200	Metal Film Resistor	4.7K 1/4 F		05
R920	VV065200	Metal Film Resistor	4.7K 1/4 F		05
R921	HF458220	Carbon Resistor	220.0K 1/4 J		01
R922	HF457150	Carbon Resistor	15.0K 1/4 J		01
R923	HF457300	Carbon Resistor	30.0K 1/4 J		01
R924	HF454100	Carbon Resistor	10.0 1/4 J		01

*: New Parts

RANK : Japan only

REF NO.	PART NO.	DESCRIPTION		REMARKS	QTY	RANK
R925	HF458220	Carbon Resistor	220.0K 1/4 J			01
R926	HF458220	Carbon Resistor	220.0K 1/4 J			01
R927	HF457100	Carbon Resistor	10.0K 1/4 J			01
R928	HF456470	Carbon Resistor	4.7K 1/4 J			01
R929	HF457330	Carbon Resistor	33.0K 1/4 J			01
R930	HF457100	Carbon Resistor	10.0K 1/4 J			01
R931	HF856560	Carbon Resistor	5.6K 1/4 J			01
R932	HF456470	Carbon Resistor	4.7K 1/4 J			01
R933	HF456820	Carbon Resistor	8.2K 1/4 J			01
R934	HF456470	Carbon Resistor	4.7K 1/4 J			01
R935	HF456820	Carbon Resistor	8.2K 1/4 J			01
R936	HF454100	Carbon Resistor	10.0 1/4 J			01
R937	HF458220	Carbon Resistor	220.0K 1/4 J			01
R938	HF858100	Carbon Resistor	100.0K 1/4 J			01
R939	HF456820	Carbon Resistor	8.2K 1/4 J			01
R940	HF858100	Carbon Resistor	100.0K 1/4 J			01
R941	HF456470	Carbon Resistor	4.7K 1/4 J			01
R942	HF858100	Carbon Resistor	100.0K 1/4 J			01
R943	HF456330	Carbon Resistor	3.3K 1/4 J			01
R944	HF456510	Carbon Resistor	5.1K 1/4 J			01
R945	HF456510	Carbon Resistor	5.1K 1/4 J			01
R946	HF454220	Carbon Resistor	22.0 1/4 J			01
R947	HF456510	Carbon Resistor	5.1K 1/4 J			01
R948	HF456510	Carbon Resistor	5.1K 1/4 J			01
R949	HF454220	Carbon Resistor	22.0 1/4 J			01
R950	HF455220	Carbon Resistor	220.0 1/4 J			01
R951	HF457180	Carbon Resistor	18.0K 1/4 J			01
R952	HF455220	Carbon Resistor	220.0 1/4 J			01
R953	HF456470	Carbon Resistor	4.7K 1/4 J			01
R954	HF457100	Carbon Resistor	10.0K 1/4 J			01
R955	HF454100	Carbon Resistor	10.0 1/4 J			01
R956	HF458220	Carbon Resistor	220.0K 1/4 J			01
R957	HF457180	Carbon Resistor	18.0K 1/4 J			01
-970	HF457180	Carbon Resistor	18.0K 1/4 J			01
R1001	VV065200	Metal Film Resistor	4.7K 1/4 F			05
R1002	VZ598300	Metal Film Resistor	510.0 1/4 F			01
R1003	VV065200	Metal Film Resistor	4.7K 1/4 F			05
-1005	VV065200	Metal Film Resistor	4.7K 1/4 F			05
R1006	HF454100	Carbon Resistor	10.0 1/4 J			01
R1007	HF454100	Carbon Resistor	10.0 1/4 J			01
R1008	VV066100	Metal Film Resistor	47K 1/4 F			01
R1009	VV066100	Metal Film Resistor	47K 1/4 F			01
R1010	HF454100	Carbon Resistor	10.0 1/4 J			01
R1011	VV065100	Metal Film Resistor	2.2K 1/4 F			01
R1012	VV065400	Metal Film Resistor	8.2K 1/4 F			01
R1013	VV064900	Metal Film Resistor	20.0 1/4 F			01
R1014	VV065900	Metal Film Resistor	24K 1/4 F			01
R1015	VV065100	Metal Film Resistor	2.2K 1/4 F			01
R1016	VV065400	Metal Film Resistor	8.2K 1/4 F			01
R1017	VV065900	Metal Film Resistor	24K 1/4 F			01
R1018	HF454100	Carbon Resistor	10.0 1/4 J			01
R1019	VV065200	Metal Film Resistor	4.7K 1/4 F			05
R1020	VV065200	Metal Film Resistor	4.7K 1/4 F			05
R1021	HF458220	Carbon Resistor	220.0K 1/4 J			01
R1022	HF457150	Carbon Resistor	15.0K 1/4 J			01
R1023	HF457300	Carbon Resistor	30.0K 1/4 J			01
R1024	HF454100	Carbon Resistor	10.0 1/4 J			01
R1025	HF458220	Carbon Resistor	220.0K 1/4 J			01
R1026	HF458220	Carbon Resistor	220.0K 1/4 J			01
R1027	HF457100	Carbon Resistor	10.0K 1/4 J			01
R1028	HF456470	Carbon Resistor	4.7K 1/4 J			01
R1029	HF457330	Carbon Resistor	33.0K 1/4 J			01
R1030	HF457100	Carbon Resistor	10.0K 1/4 J			01
R1031	HF856560	Carbon Resistor	5.6K 1/4 J			01
R1032	HF456470	Carbon Resistor	4.7K 1/4 J			01
R1033	HF456820	Carbon Resistor	8.2K 1/4 J			01
R1034	HF456470	Carbon Resistor	4.7K 1/4 J			01
R1035	HF456820	Carbon Resistor	8.2K 1/4 J			01
R1036	HF454100	Carbon Resistor	10.0 1/4 J			01
R1037	HF458220	Carbon Resistor	220.0K 1/4 J			01

* : New Parts

RANK : Japan only

REF NO.	PART NO.	DESCRIPTION	REMARKS	QTY	RANK
R1038	HF858100	Carbon Resistor	100.0K 1/4 J		01
R1039	HF456820	Carbon Resistor	8.2K 1/4 J		01
R1040	HF858100	Carbon Resistor	100.0K 1/4 J		01
R1041	HF456470	Carbon Resistor	4.7K 1/4 J		01
R1042	HF858100	Carbon Resistor	100.0K 1/4 J		01
R1043	HF456330	Carbon Resistor	3.3K 1/4 J		01
R1044	HF456510	Carbon Resistor	5.1K 1/4 J		01
R1045	HF456510	Carbon Resistor	5.1K 1/4 J		01
R1046	HF454220	Carbon Resistor	22.0 1/4 J		01
R1047	HF456510	Carbon Resistor	5.1K 1/4 J		01
R1048	HF456510	Carbon Resistor	5.1K 1/4 J		01
R1049	HF454220	Carbon Resistor	22.0 1/4 J		01
R1050	HF455220	Carbon Resistor	220.0 1/4 J		01
R1051	HF457180	Carbon Resistor	18.0K 1/4 J		01
R1052	HF455220	Carbon Resistor	220.0 1/4 J		01
R1053	HF456470	Carbon Resistor	4.7K 1/4 J		01
R1054	HF457100	Carbon Resistor	10.0K 1/4 J		01
R1055	HF454100	Carbon Resistor	10.0 1/4 J		01
R1056	HF458220	Carbon Resistor	220.0K 1/4 J		01
R1057	HF457180	Carbon Resistor	18.0K 1/4 J		01
-1070	HF457180	Carbon Resistor	18.0K 1/4 J		01
R2001	VV065200	Metal Film Resistor	4.7K 1/4 F		05
R2002	VZ598300	Metal Film Resistor	510.0 1/4 F		01
R2003	VV065200	Metal Film Resistor	4.7K 1/4 F		05
-2005	VV065200	Metal Film Resistor	4.7K 1/4 F		05
R2006	HF454100	Carbon Resistor	10.0 1/4 J		01
R2007	HF454100	Carbon Resistor	10.0 1/4 J		01
R2008	VV066100	Metal Film Resistor	47K 1/4 F		01
R2009	VV066100	Metal Film Resistor	47K 1/4 F		01
R2010	HF454100	Carbon Resistor	10.0 1/4 J		01
R2011	VV065100	Metal Film Resistor	2.2K 1/4 F		01
R2012	VV065400	Metal Film Resistor	8.2K 1/4 F		01
R2013	VV064900	Metal Film Resistor	20.0 1/4 F		01
R2014	VV065900	Metal Film Resistor	24K 1/4 F		01
R2015	VV065100	Metal Film Resistor	2.2K 1/4 F		01
R2016	VV065400	Metal Film Resistor	8.2K 1/4 F		01
R2017	VV065900	Metal Film Resistor	24K 1/4 F		01
R2018	HF454100	Carbon Resistor	10.0 1/4 J		01
R2019	VV065200	Metal Film Resistor	4.7K 1/4 F		05
R2020	VV065200	Metal Film Resistor	4.7K 1/4 F		05
R2021	HF458220	Carbon Resistor	220.0K 1/4 J		01
R2022	HF457150	Carbon Resistor	15.0K 1/4 J		01
R2023	HF457300	Carbon Resistor	30.0K 1/4 J		01
R2024	HF454100	Carbon Resistor	10.0 1/4 J		01
R2025	HF458220	Carbon Resistor	220.0K 1/4 J		01
R2026	HF458220	Carbon Resistor	220.0K 1/4 J		01
R2027	HF457100	Carbon Resistor	10.0K 1/4 J		01
R2028	HF456470	Carbon Resistor	4.7K 1/4 J		01
R2029	HF457330	Carbon Resistor	33.0K 1/4 J		01
R2030	HF457100	Carbon Resistor	10.0K 1/4 J		01
R2031	HF856560	Carbon Resistor	5.6K 1/4 J		01
R2032	HF456470	Carbon Resistor	4.7K 1/4 J		01
R2033	HF456820	Carbon Resistor	8.2K 1/4 J		01
R2034	HF456470	Carbon Resistor	4.7K 1/4 J		01
R2035	HF456820	Carbon Resistor	8.2K 1/4 J		01
R2036	HF454100	Carbon Resistor	10.0 1/4 J		01
R2037	HF458220	Carbon Resistor	220.0K 1/4 J		01
R2038	HF858100	Carbon Resistor	100.0K 1/4 J		01
R2039	HF456820	Carbon Resistor	8.2K 1/4 J		01
R2040	HF858100	Carbon Resistor	100.0K 1/4 J		01
R2041	HF456470	Carbon Resistor	4.7K 1/4 J		01
R2042	HF858100	Carbon Resistor	100.0K 1/4 J		01
R2043	HF456330	Carbon Resistor	3.3K 1/4 J		01
R2044	HF456510	Carbon Resistor	5.1K 1/4 J		01
R2045	HF456510	Carbon Resistor	5.1K 1/4 J		01
R2046	HF454220	Carbon Resistor	22.0 1/4 J		01
R2047	HF456510	Carbon Resistor	5.1K 1/4 J		01
R2048	HF456510	Carbon Resistor	5.1K 1/4 J		01
R2049	HF454220	Carbon Resistor	22.0 1/4 J		01
R2050	HF455220	Carbon Resistor	220.0 1/4 J		01

*: New Parts

RANK : Japan only

GF24/12
GF16/12
GF12/12

REF NO.	PART NO.	DESCRIPTION		REMARKS	QTY	RANK
R2051	HF457180	Carbon Resistor	18.0K 1/4 J			01
R2052	HF455220	Carbon Resistor	220.0 1/4 J			01
R2053	HF456470	Carbon Resistor	4.7K 1/4 J			01
R2054	HF457100	Carbon Resistor	10.0K 1/4 J			01
R2055	HF454100	Carbon Resistor	10.0 1/4 J			01
R2056	HF458220	Carbon Resistor	220.0K 1/4 J			01
R2057	HF457180	Carbon Resistor	18.0K 1/4 J			01
-2070	HF457180	Carbon Resistor	18.0K 1/4 J			01
R3001	VV065200	Metal Film Resistor	4.7K 1/4 F			05
R3002	VZ598300	Metal Film Resistor	510.0 1/4 F			01
R3003	VV065200	Metal Film Resistor	4.7K 1/4 F			05
-3005	VV065200	Metal Film Resistor	4.7K 1/4 F			05
R3006	HF454100	Carbon Resistor	10.0 1/4 J			01
R3007	HF454100	Carbon Resistor	10.0 1/4 J			01
R3008	VV066100	Metal Film Resistor	47K 1/4 F			01
R3009	VV066100	Metal Film Resistor	47K 1/4 F			01
R3010	HF454100	Carbon Resistor	10.0 1/4 J			01
R3011	VV065100	Metal Film Resistor	2.2K 1/4 F			01
R3012	VV065400	Metal Film Resistor	8.2K 1/4 F			01
R3013	VV064900	Metal Film Resistor	20.0 1/4 F			01
R3014	VV065900	Metal Film Resistor	24K 1/4 F			01
R3015	VV065100	Metal Film Resistor	2.2K 1/4 F			01
R3016	VV065400	Metal Film Resistor	8.2K 1/4 F			01
R3017	VV065900	Metal Film Resistor	24K 1/4 F			01
R3018	HF454100	Carbon Resistor	10.0 1/4 J			01
R3019	VV065200	Metal Film Resistor	4.7K 1/4 F			05
R3020	VV065200	Metal Film Resistor	4.7K 1/4 F			05
R3021	HF458220	Carbon Resistor	220.0K 1/4 J			01
R3022	HF457150	Carbon Resistor	15.0K 1/4 J			01
R3023	HF457300	Carbon Resistor	30.0K 1/4 J			01
R3024	HF454100	Carbon Resistor	10.0 1/4 J			01
R3025	HF458220	Carbon Resistor	220.0K 1/4 J			01
R3026	HF458220	Carbon Resistor	220.0K 1/4 J			01
R3027	HF457100	Carbon Resistor	10.0K 1/4 J			01
R3028	HF456470	Carbon Resistor	4.7K 1/4 J			01
R3029	HF457330	Carbon Resistor	33.0K 1/4 J			01
R3030	HF457100	Carbon Resistor	10.0K 1/4 J			01
R3031	HF856560	Carbon Resistor	5.6K 1/4 J			01
R3032	HF456470	Carbon Resistor	4.7K 1/4 J			01
R3033	HF456820	Carbon Resistor	8.2K 1/4 J			01
R3034	HF456470	Carbon Resistor	4.7K 1/4 J			01
R3035	HF456820	Carbon Resistor	8.2K 1/4 J			01
R3036	HF454100	Carbon Resistor	10.0 1/4 J			01
R3037	HF458220	Carbon Resistor	220.0K 1/4 J			01
R3038	HF858100	Carbon Resistor	100.0K 1/4 J			01
R3039	HF456820	Carbon Resistor	8.2K 1/4 J			01
R3040	HF858100	Carbon Resistor	100.0K 1/4 J			01
R3041	HF456470	Carbon Resistor	4.7K 1/4 J			01
R3042	HF858100	Carbon Resistor	100.0K 1/4 J			01
R3043	HF456330	Carbon Resistor	3.3K 1/4 J			01
R3044	HF456510	Carbon Resistor	5.1K 1/4 J			01
R3045	HF456510	Carbon Resistor	5.1K 1/4 J			01
R3046	HF454220	Carbon Resistor	22.0 1/4 J			01
R3047	HF456510	Carbon Resistor	5.1K 1/4 J			01
R3048	HF456510	Carbon Resistor	5.1K 1/4 J			01
R3049	HF454220	Carbon Resistor	22.0 1/4 J			01
R3050	HF455220	Carbon Resistor	220.0 1/4 J			01
R3051	HF457180	Carbon Resistor	18.0K 1/4 J			01
R3052	HF455220	Carbon Resistor	220.0 1/4 J			01
R3053	HF456470	Carbon Resistor	4.7K 1/4 J			01
R3054	HF457100	Carbon Resistor	10.0K 1/4 J			01
R3055	HF454100	Carbon Resistor	10.0 1/4 J			01
R3056	HF458220	Carbon Resistor	220.0K 1/4 J			01
R3057	HF457180	Carbon Resistor	18.0K 1/4 J			01
-3070	HF457180	Carbon Resistor	18.0K 1/4 J			01
SW101	VZ587700	Push Switch		(GF24/12:9ch,GF16/12:1ch)		01
-109	VZ587700	Push Switch		PAD,HPF,PRE3-4,PRE5-6,ON,		01
				1-2,3-4,ST,PFL		
SW201	VZ587700	Push Switch		(GF24/12:10ch,GF16/12:2ch)		01
-209	VZ587700	Push Switch		PAD,HPF,PRE3-4,PRE5-6,ON,		01

* : New Parts

RANK : Japan only

REF NO.	PART NO.	DESCRIPTION		REMARKS	QTY	RANK
SW301	VZ587700	Push Switch		1-2,3-4,ST,PFL		01
-309	VZ587700	Push Switch		(GF24/12:11ch,GF16/12:3ch)		01
				PAD,HPF,PRE3-4,PRE5-6,ON,		
				1-2,3-4,ST,PFL		
SW401	VZ587700	Push Switch		(GF24/12:12ch,GF16/12:4ch)		01
-409	VZ587700	Push Switch		PAD,HPF,PRE3-4,PRE5-6,ON,		01
				1-2,3-4,ST,PFL		
SW501	VZ587700	Push Switch		(GF24/12:13ch,GF16/12:5ch)		01
-509	VZ587700	Push Switch		PAD,HPF,PRE3-4,PRE5-6,ON,		01
				1-2,3-4,ST,PFL		
SW601	VZ587700	Push Switch		(GF24/12:14ch,GF16/12:6ch)		01
-609	VZ587700	Push Switch		PAD,HPF,PRE3-4,PRE5-6,ON,		01
				1-2,3-4,ST,PFL		
SW701	VZ587700	Push Switch		(GF24/12:15ch,GF16/12:7ch)		01
-709	VZ587700	Push Switch		PAD,HPF,PRE3-4,PRE5-6,ON,		01
				1-2,3-4,ST,PFL		
SW801	VZ587700	Push Switch		(GF24/12:16ch,GF16/12:8ch)		01
-809	VZ587700	Push Switch		PAD,HPF,PRE3-4,PRE5-6,ON,		01
				1-2,3-4,ST,PFL		
SW901	VZ587700	Push Switch		(GF24/12:17-20ch,		01
-936	VZ587700	Push Switch		GF16/12:9-12ch)		01
				PAD,HPF,PRE3-4,PRE5-6,ON,		
				1-2,3-4,ST,PFL		
VR101	VU804500	Rotary Variable Resistor	RD 5.0K RK09K113	PAD(GF24/12:9ch,		04
				GF16/12:1ch)		
VR102	V3161000	Rotary Variable Resistor	B 50.0K RK09D113	LOW(GF24/12:9ch,		04
				GF16/12:1ch)		
VR103	V3161000	Rotary Variable Resistor	B 50.0K RK09D113	HIGH(GF24/12:9ch,		04
				GF16/12:1ch)		
VR104	VZ611200	Rotary Variable Resistor	C 100K RK12L123	MID-F(GF24/12:9ch,		
				GF16/12:1ch)		
* VR105	V3161100	Rotary Variable Resistor	W 20.0K RK09D113	MID(GF24/12:9ch,		
				GF16/12:1ch)		
VR106	VU804100	Slide Variable Resistor	RS6011YG6036-10KA	Fader(GF24/12:9ch,		04
				GF16/12:1ch)		
VR107	VZ610800	Rotary Variable Resistor	AC 20K RK12L123	PAN(GF24/12:9ch,		03
				GF16/12:1ch)		
VR108	VU804600	Rotary Variable Resistor	A 20.0K RK09K113	A1-A6(GF24/12:9ch,		04
-113	VU804600	Rotary Variable Resistor	A 20.0K RK09K113	GF16/12:1ch)		04
VR201	VU804500	Rotary Variable Resistor	RD 5.0K RK09K113	PAD(GF24/12:10ch,		04
				GF16/12:2ch)		
VR202	V3161000	Rotary Variable Resistor	B 50.0K RK09D113	LOW(GF24/12:10ch,		04
				GF16/12:2ch)		
VR203	V3161000	Rotary Variable Resistor	B 50.0K RK09D113	HIGH(GF24/12:10ch,		04
				GF16/12:2ch)		
VR204	VZ611200	Rotary Variable Resistor	C 100K RK12L123	MID-F(GF24/12:10ch,		
				GF16/12:2ch)		
* VR205	V3161100	Rotary Variable Resistor	W 20.0K RK09D113	MID(GF24/12:10ch,		
				GF16/12:2ch)		
VR206	VU804100	Slide Variable Resistor	RS6011YG6036-10KA	Fader(GF24/12:10ch,		04
				GF16/12:2ch)		
VR207	VZ610800	Rotary Variable Resistor	AC 20K RK12L123	PAN(GF24/12:10ch,		03
				GF16/12:2ch)		
VR208	VU804600	Rotary Variable Resistor	A 20.0K RK09K113	A1-A6(GF24/12:10ch,		04
-213	VU804600	Rotary Variable Resistor	A 20.0K RK09K113	GF16/12:2ch)		04
VR301	VU804500	Rotary Variable Resistor	RD 5.0K RK09K113	PAD(GF24/12:11ch,		04
				GF16/12:3ch)		
VR302	V3161000	Rotary Variable Resistor	B 50.0K RK09D113	LOW(GF24/12:11ch,		04
				GF16/12:3ch)		
VR303	V3161000	Rotary Variable Resistor	B 50.0K RK09D113	HIGH(GF24/12:11ch,		04
				GF16/12:3ch)		
VR304	VZ611200	Rotary Variable Resistor	C 100K RK12L123	MID-F(GF24/12:11ch,		
				GF16/12:3ch)		
* VR305	V3161100	Rotary Variable Resistor	W 20.0K RK09D113	MID(GF24/12:11ch,		
				GF16/12:3ch)		
VR306	VU804100	Slide Variable Resistor	RS6011YG6036-10KA	Fader(GF24/12:11ch,		04
				GF16/12:3ch)		
VR307	VZ610800	Rotary Variable Resistor	AC 20K RK12L123	PAN(GF24/12:11ch,		03
				GF16/12:3ch)		
VR308	VU804600	Rotary Variable Resistor	A 20.0K RK09K113	A1-A6(GF24/12:11ch,		04

*: New Parts

RANK : Japan only

REF NO.	PART NO.	DESCRIPTION		REMARKS	QTY	RANK
-313	VU804600	Rotary Variable Resistor	A 20.0K RK09K113	GF16/12:3ch)		04
VR401	VU804500	Rotary Variable Resistor	RD 5.0K RK09K113	PAD(GF24/12:12ch, GF16/12:4ch)		04
VR402	V3161000	Rotary Variable Resistor	B 50.0K RK09D113	LOW(GF24/12:12ch, GF16/12:4ch)		04
VR403	V3161000	Rotary Variable Resistor	B 50.0K RK09D113	HIGH(GF24/12:12ch, GF16/12:4ch)		04
VR404	VZ611200	Rotary Variable Resistor	C 100K RK12L123	MID-F(GF24/12:12ch, GF16/12:4ch)		04
* VR405	V3161100	Rotary Variable Resistor	W 20.0K RK09D113	MID(GF24/12:12ch, GF16/12:4ch)		04
VR406	VU804100	Slide Variable Resistor	RS6011YG6036-10KA	Fader(GF24/12:12ch, GF16/12:4ch)		04
VR407	VZ610800	Rotary Variable Resistor	AC 20K RK12L123	PAN(GF24/12:12ch, GF16/12:4ch)		03
VR408	VU804600	Rotary Variable Resistor	A 20.0K RK09K113	A1-A6(GF24/12:12ch, GF16/12:4ch)		04
-413	VU804600	Rotary Variable Resistor	A 20.0K RK09K113	GF16/12:4ch)		04
VR501	VU804500	Rotary Variable Resistor	RD 5.0K RK09K113	PAD(GF24/12:13ch, GF16/12:5ch)		04
VR502	V3161000	Rotary Variable Resistor	B 50.0K RK09D113	LOW(GF24/12:13ch, GF16/12:5ch)		04
VR503	V3161000	Rotary Variable Resistor	B 50.0K RK09D113	HIGH(GF24/12:13ch, GF16/12:5ch)		04
VR504	VZ611200	Rotary Variable Resistor	C 100K RK12L123	MID-F(GF24/12:13ch, GF16/12:5ch)		04
* VR505	V3161100	Rotary Variable Resistor	W 20.0K RK09D113	MID(GF24/12:13ch, GF16/12:5ch)		04
VR506	VU804100	Slide Variable Resistor	RS6011YG6036-10KA	Fader(GF24/12:13ch, GF16/12:5ch)		04
VR507	VZ610800	Rotary Variable Resistor	AC 20K RK12L123	PAN(GF24/12:13ch, GF16/12:5ch)		03
VR508	VU804600	Rotary Variable Resistor	A 20.0K RK09K113	A1-A6(GF24/12:13ch, GF16/12:5ch)		04
-513	VU804600	Rotary Variable Resistor	A 20.0K RK09K113	GF16/12:5ch)		04
VR601	VU804500	Rotary Variable Resistor	RD 5.0K RK09K113	PAD(GF24/12:14ch, GF16/12:6ch)		04
VR602	V3161000	Rotary Variable Resistor	B 50.0K RK09D113	LOW(GF24/12:14ch, GF16/12:6ch)		04
VR603	V3161000	Rotary Variable Resistor	B 50.0K RK09D113	HIGH(GF24/12:14ch, GF16/12:6ch)		04
VR604	VZ611200	Rotary Variable Resistor	C 100K RK12L123	MID-F(GF24/12:14ch, GF16/12:6ch)		04
* VR605	V3161100	Rotary Variable Resistor	W 20.0K RK09D113	MID(GF24/12:14ch, GF16/12:6ch)		04
VR606	VU804100	Slide Variable Resistor	RS6011YG6036-10KA	Fader(GF24/12:14ch, GF16/12:6ch)		04
VR607	VZ610800	Rotary Variable Resistor	AC 20K RK12L123	PAN(GF24/12:14ch, GF16/12:6ch)		03
VR608	VU804600	Rotary Variable Resistor	A 20.0K RK09K113	A1-A6(GF24/12:14ch, GF16/12:6ch)		04
-613	VU804600	Rotary Variable Resistor	A 20.0K RK09K113	GF16/12:6ch)		04
VR701	VU804500	Rotary Variable Resistor	RD 5.0K RK09K113	PAD(GF24/12:15ch, GF16/12:7ch)		04
VR702	V3161000	Rotary Variable Resistor	B 50.0K RK09D113	LOW(GF24/12:15ch, GF16/12:7ch)		04
VR703	V3161000	Rotary Variable Resistor	B 50.0K RK09D113	HIGH(GF24/12:15ch, GF16/12:7ch)		04
VR704	VZ611200	Rotary Variable Resistor	C 100K RK12L123	MID-F(GF24/12:15ch, GF16/12:7ch)		04
* VR705	V3161100	Rotary Variable Resistor	W 20.0K RK09D113	MID(GF24/12:15ch, GF16/12:7ch)		04
VR706	VU804100	Slide Variable Resistor	RS6011YG6036-10KA	Fader(GF24/12:15ch, GF16/12:7ch)		04
VR707	VZ610800	Rotary Variable Resistor	AC 20K RK12L123	PAN(GF24/12:15ch, GF16/12:7ch)		03
VR708	VU804600	Rotary Variable Resistor	A 20.0K RK09K113	A1-A6(GF24/12:15ch, GF16/12:7ch)		04
-713	VU804600	Rotary Variable Resistor	A 20.0K RK09K113	GF16/12:7ch)		04
VR801	VU804500	Rotary Variable Resistor	RD 5.0K RK09K113	PAD(GF24/12:16ch, GF16/12:8ch)		04
VR802	V3161000	Rotary Variable Resistor	B 50.0K RK09D113	LOW(GF24/12:16ch, GF16/12:8ch)		04
VR803	V3161000	Rotary Variable Resistor	B 50.0K RK09D113	HIGH(GF24/12:16ch, GF16/12:8ch)		04

* : New Parts

RANK : Japan only

REF NO.	PART NO.	DESCRIPTION		REMARKS	QTY	RANK
VR804	VZ611200	Rotary Variable Resistor	C 100K RK12L123	GF16/12:8ch)		
* VR805	V3161100	Rotary Variable Resistor	W 20.0K RK09D113	MID-F(GF24/12:16ch, GF16/12:8ch)		
VR806	VU804100	Slide Variable Resistor	RS6011YG6036-10KA	MID(GF24/12:16ch, GF16/12:8ch)		04
VR807	VZ610800	Rotary Variable Resistor	AC 20K RK12L123	Fader(GF24/12:16ch, GF16/12:8ch)		03
VR808	VU804600	Rotary Variable Resistor	A 20.0K RK09K113	PAN(GF24/12:16ch, GF16/12:8ch)		04
-813	VU804600	Rotary Variable Resistor	A 20.0K RK09K113	A1-A6(GF24/12:16ch, GF16/12:8ch)		04
VR901	VU804500	Rotary Variable Resistor	RD 5.0K RK09K113	PAD(GF24/12:17-20ch, GF16/12:9-12ch)		04
-904	VU804500	Rotary Variable Resistor	RD 5.0K RK09K113	LOW(GF24/12:17-20ch, GF16/12:9-12)		04
VR905	V3161000	Rotary Variable Resistor	B 50.0K RK09D113	HIGH(GF24/12:17-20, GF16/12:9-12)		04
-912	V3161000	Rotary Variable Resistor	B 50.0K RK09D113	MID-f(GF24/12:17-20) GF16/12:9-12)		04
VR913	VZ611200	Rotary Variable Resistor	C 100K RK12L123	Fader(GF24/12:17ch, GF16/12:9ch)		04
-916	VZ611200	Rotary Variable Resistor	C 100K RK12L123	PAN(GF24/12:17ch, GF16/12:9ch)		03
* VR917	V3161100	Rotary Variable Resistor	W 20.0K RK09D113	A1-A6(GF24/12:17ch, GF16/12:9ch)		04
-920	V3161100	Rotary Variable Resistor	W 20.0K RK09D113	GF16/12:10ch)		04
* VR921	VU804100	Slide Variable Resistor	RS6011YG6036-10KA	Fader(GF24/12:18ch, GF16/12:10ch)		04
VR922	VZ610800	Rotary Variable Resistor	AC 20K RK12L123	PAN(GF24/12:18ch, GF16/12:10ch)		03
VR923	VU804600	Rotary Variable Resistor	A 20.0K RK09K113	A1-A6(GF24/12:18ch, GF16/12:10ch)		04
-928	VU804600	Rotary Variable Resistor	A 20.0K RK09K113	GF16/12:11ch)		04
VR929	VU804100	Slide Variable Resistor	RS6011YG6036-10KA	Fader(GF24/12:19ch, GF16/12:11ch)		04
VR930	VZ610800	Rotary Variable Resistor	AC 20K RK12L123	PAN(GF24/12:19ch, GF16/12:11ch)		03
VR931	VU804600	Rotary Variable Resistor	A 20.0K RK09K113	A1-A6(GF24/12:19ch, GF16/12:11ch)		04
-936	VU804600	Rotary Variable Resistor	A 20.0K RK09K113	GF16/12:12ch)		04
VR937	VU804100	Slide Variable Resistor	RS6011YG6036-10KA	Fader(GF24/12:20ch, GF16/12:12ch)		04
VR938	VZ610800	Rotary Variable Resistor	AC 20K RK12L123	PAN(GF24/12:20ch, GF16/12:12ch)		03
VR939	VU804600	Rotary Variable Resistor	A 20.0K RK09K113	A1-A6(GF24/12:20ch, GF16/12:12ch)		04
-944	VU804600	Rotary Variable Resistor	A 20.0K RK09K113	GF16/12:13-14,15-16ch		04
VR945	VU804100	Slide Variable Resistor	RS6011YG6036-10KA	Fader(GF24/12:21-22,23-24ch GF16/12:13-14,15-16ch GF12/12:9-10,11-12ch	(V288420,XV334B0)	04
VR946	VZ610800	Rotary Variable Resistor	AC 20K RK12L123			03
VR947	VU804600	Rotary Variable Resistor	A 20.0K RK09K113			04
-952	VU804600	Rotary Variable Resistor	A 20.0K RK09K113			04
*	AAX00110	Circuit Board	MAS 1/3			
*	AAX00120	Circuit Board	MAS 2/3			
*	AAX00130	Circuit Board	MAS 3/3			
*	VZ336400	Plastic Rivet	PR-05A GIN LIAN			01
*	V3297600	Earth Terminal				
	VV307300	Spacer, LED				01
	VZ968500	Button	NO.947 CD-GRAY			01
	VZ968600	Button	NO.947 CD-GRAY			01
	VZ968700	Button	NO.946 CL-GRAY			01
	V2947200	Button	MX-BLUE			
*	XV439A00	LED SPACER	LED SPACER			
C101	UM417100	Electrolytic Cap.	10.00 25.0V			01
C102	UM417100	Electrolytic Cap.	10.00 25.0V			01
C103	VZ353500	Ceramic Capacitor-SL	100P 50V J			01
C104	VV330700	Electrolytic Cap.	470.00 10.0V			01
C105	VZ353500	Ceramic Capacitor-SL	100P 50V J			01
C106	VV330700	Electrolytic Cap.	470.00 10.0V			01
C107	VZ353500	Ceramic Capacitor-SL	100P 50V J			01
C108	VZ353500	Ceramic Capacitor-SL	100P 50V J			01
C109	VZ354000	Ceramic Capacitor-F	0.0100 50V Z			01
C110	VZ353200	Ceramic Capacitor-SL	47P 50V J			01
C111	VZ353200	Ceramic Capacitor-SL	47P 50V J			01
C112	VZ354000	Ceramic Capacitor-F	0.0100 50V Z			01

*: New Parts

RANK : Japan only

GF24/12
GF16/12
GF12/12

REF NO.	PART NO.	DESCRIPTION		REMARKS	QTY	RANK
C113	UM417100	Electrolytic Cap.	10.00 25.0V			01
C114	UM417100	Electrolytic Cap.	10.00 25.0V			01
C115	VZ597300	Mylar Capacitor	0.091 50V J			01
-118	VZ597300	Mylar Capacitor	0.091 50V J			01
C119	VZ354000	Ceramic Capacitor-F	0.0100 50V Z			01
C120	VZ354000	Ceramic Capacitor-F	0.0100 50V Z			01
C121	UM417100	Electrolytic Cap.	10.00 25.0V			01
-124	UM417100	Electrolytic Cap.	10.00 25.0V			01
C125	VV062300	Mylar Capacitor	0.039 50V J			01
C126	VV062300	Mylar Capacitor	0.039 50V J			01
C127	VV190000	Mylar Capacitor	820P 50V J			01
C128	VV190000	Mylar Capacitor	820P 50V J			01
C129	VZ353200	Ceramic Capacitor-SL	47P 50V J			01
C130	VZ353500	Ceramic Capacitor-SL	100P 50V J			01
C131	VZ353200	Ceramic Capacitor-SL	47P 50V J			01
C132	VZ353500	Ceramic Capacitor-SL	100P 50V J			01
C133	VV061000	Mylar Capacitor	5600P 50V J			01
C134	VV061000	Mylar Capacitor	5600P 50V J			01
C135	VV060300	Mylar Capacitor	2200P 50V J			01
C136	VV060300	Mylar Capacitor	2200P 50V J			01
C137	VZ352800	Ceramic Capacitor-SL	22P 50V J			01
C138	VZ352800	Ceramic Capacitor-SL	22P 50V J			01
C139	UJ667470	Electrolytic Cap.	47.00 25.0V			01
C140	UJ667470	Electrolytic Cap.	47.00 25.0V			01
C141	VZ353900	Ceramic Cap.-B	1000P 50V K			01
C142	VZ354000	Ceramic Capacitor-F	0.0100 50V Z			01
C143	UM417100	Electrolytic Cap.	10.00 25.0V			01
C144	UM417100	Electrolytic Cap.	10.00 25.0V			01
C145	VV062400	Mylar Capacitor	0.047 50V J			01
C146	VZ354000	Ceramic Capacitor-F	0.0100 50V Z			01
C147	VZ353500	Ceramic Capacitor-SL	100P 50V J			01
C148	VZ353500	Ceramic Capacitor-SL	100P 50V J			01
C149	VZ354000	Ceramic Capacitor-F	0.0100 50V Z			01
C150	VZ353500	Ceramic Capacitor-SL	100P 50V J			01
C151	VZ353500	Ceramic Capacitor-SL	100P 50V J			01
C152	VZ354000	Ceramic Capacitor-F	0.0100 50V Z			01
C153	VZ353200	Ceramic Capacitor-SL	47P 50V J			01
C154	VZ353200	Ceramic Capacitor-SL	47P 50V J			01
C155	UJ667470	Electrolytic Cap.	47.00 25.0V			01
C156	UJ667470	Electrolytic Cap.	47.00 25.0V			01
C157	VZ353200	Ceramic Capacitor-SL	47P 50V J			01
-164	VZ353200	Ceramic Capacitor-SL	47P 50V J			01
C165	UJ667470	Electrolytic Cap.	47.00 25.0V			01
C166	UJ667470	Electrolytic Cap.	47.00 25.0V			01
C167	VZ353500	Ceramic Capacitor-SL	100P 50V J			01
C168	VZ353500	Ceramic Capacitor-SL	100P 50V J			01
C169	VZ353200	Ceramic Capacitor-SL	47P 50V J			01
C170	VZ353200	Ceramic Capacitor-SL	47P 50V J			01
C171	UM417100	Electrolytic Cap.	10.00 25.0V			01
C172	UM417100	Electrolytic Cap.	10.00 25.0V			01
C173	VZ354000	Ceramic Capacitor-F	0.0100 50V Z			01
C174	VZ354000	Ceramic Capacitor-F	0.0100 50V Z			01
C201	UM417100	Electrolytic Cap.	10.00 25.0V			01
C202	UM417100	Electrolytic Cap.	10.00 25.0V			01
C203	VZ353500	Ceramic Capacitor-SL	100P 50V J			01
C204	VV330700	Electrolytic Cap.	470.00 10.0V			01
C205	VZ353500	Ceramic Capacitor-SL	100P 50V J			01
C206	VV330700	Electrolytic Cap.	470.00 10.0V			01
C207	VZ353500	Ceramic Capacitor-SL	100P 50V J			01
C208	VZ353500	Ceramic Capacitor-SL	100P 50V J			01
C209	VZ354000	Ceramic Capacitor-F	0.0100 50V Z			01
C210	VZ353200	Ceramic Capacitor-SL	47P 50V J			01
C211	VZ353200	Ceramic Capacitor-SL	47P 50V J			01
C212	VZ354000	Ceramic Capacitor-F	0.0100 50V Z			01
C213	UM417100	Electrolytic Cap.	10.00 25.0V			01
C214	UM417100	Electrolytic Cap.	10.00 25.0V			01
C215	VZ597300	Mylar Capacitor	0.091 50V J			01
-218	VZ597300	Mylar Capacitor	0.091 50V J			01
C219	VZ354000	Ceramic Capacitor-F	0.0100 50V Z			01
C220	VZ354000	Ceramic Capacitor-F	0.0100 50V Z			01

* : New Parts

RANK : Japan only

REF NO.	PART NO.	DESCRIPTION		REMARKS	QTY	RANK
C221	UM417100	Electrolytic Cap.	10.00 25.0V			01
-224	UM417100	Electrolytic Cap.	10.00 25.0V			01
C225	VV062300	Mylar Capacitor	0.039 50V J			01
C226	VV062300	Mylar Capacitor	0.039 50V J			01
C227	VV190000	Mylar Capacitor	820P 50V J			01
C228	VV190000	Mylar Capacitor	820P 50V J			01
C229	VZ353200	Ceramic Capacitor-SL	47P 50V J			01
C230	VZ353500	Ceramic Capacitor-SL	100P 50V J			01
C231	VZ353200	Ceramic Capacitor-SL	47P 50V J			01
C232	VZ353500	Ceramic Capacitor-SL	100P 50V J			01
C233	VV061000	Mylar Capacitor	5600P 50V J			01
C234	VV061000	Mylar Capacitor	5600P 50V J			01
C235	VV060300	Mylar Capacitor	2200P 50V J			01
C236	VV060300	Mylar Capacitor	2200P 50V J			01
C237	VZ352800	Ceramic Capacitor-SL	22P 50V J			01
C238	VZ352800	Ceramic Capacitor-SL	22P 50V J			01
C239	UJ667470	Electrolytic Cap.	47.00 25.0V			01
C240	UJ667470	Electrolytic Cap.	47.00 25.0V			01
C241	VZ353900	Ceramic Cap.-B	1000P 50V K			01
C242	VZ354000	Ceramic Capacitor-F	0.0100 50V Z			01
C243	UM417100	Electrolytic Cap.	10.00 25.0V			01
C244	UM417100	Electrolytic Cap.	10.00 25.0V			01
C245	VV062400	Mylar Capacitor	0.047 50V J			01
C246	VZ354000	Ceramic Capacitor-F	0.0100 50V Z			01
C247	VZ353500	Ceramic Capacitor-SL	100P 50V J			01
C248	VZ353500	Ceramic Capacitor-SL	100P 50V J			01
C249	VZ354000	Ceramic Capacitor-F	0.0100 50V Z			01
C250	VZ353500	Ceramic Capacitor-SL	100P 50V J			01
C251	VZ353500	Ceramic Capacitor-SL	100P 50V J			01
C252	VZ354000	Ceramic Capacitor-F	0.0100 50V Z			01
C253	VZ353200	Ceramic Capacitor-SL	47P 50V J			01
C254	VZ353200	Ceramic Capacitor-SL	47P 50V J			01
C255	UJ667470	Electrolytic Cap.	47.00 25.0V			01
C256	UJ667470	Electrolytic Cap.	47.00 25.0V			01
C257	VZ353200	Ceramic Capacitor-SL	47P 50V J			01
-264	VZ353200	Ceramic Capacitor-SL	47P 50V J			01
C265	UJ667470	Electrolytic Cap.	47.00 25.0V			01
C266	UJ667470	Electrolytic Cap.	47.00 25.0V			01
C267	VZ353500	Ceramic Capacitor-SL	100P 50V J			01
C268	VZ353500	Ceramic Capacitor-SL	100P 50V J			01
C269	VZ353200	Ceramic Capacitor-SL	47P 50V J			01
C270	VZ353200	Ceramic Capacitor-SL	47P 50V J			01
C271	UM417100	Electrolytic Cap.	10.00 25.0V			01
C272	UM417100	Electrolytic Cap.	10.00 25.0V			01
C301	VZ353900	Ceramic Cap.-B	1000P 50V K			01
C302	UM417100	Electrolytic Cap.	10.00 25.0V			01
-307	UM417100	Electrolytic Cap.	10.00 25.0V			01
C308	VZ353500	Ceramic Capacitor-SL	100P 50V J			01
-313	VZ353500	Ceramic Capacitor-SL	100P 50V J			01
C314	VZ354000	Ceramic Capacitor-F	0.0100 50V Z			01
C316	VZ353500	Ceramic Capacitor-SL	100P 50V J			01
-319	VZ353500	Ceramic Capacitor-SL	100P 50V J			01
C320	VZ353200	Ceramic Capacitor-SL	47P 50V J			01
-325	VZ353200	Ceramic Capacitor-SL	47P 50V J			01
C326	VZ354000	Ceramic Capacitor-F	0.0100 50V Z			01
C328	UM417100	Electrolytic Cap.	10.00 25.0V			01
C329	UM417100	Electrolytic Cap.	10.00 25.0V			01
C330	UJ667470	Electrolytic Cap.	47.00 25.0V			01
-333	UJ667470	Electrolytic Cap.	47.00 25.0V			01
C334	VZ354000	Ceramic Capacitor-F	0.0100 50V Z			01
C335	VZ354000	Ceramic Capacitor-F	0.0100 50V Z			01
C401	VZ354000	Ceramic Capacitor-F	0.0100 50V Z			01
-404	VZ354000	Ceramic Capacitor-F	0.0100 50V Z			01
C405	VZ353500	Ceramic Capacitor-SL	100P 50V J			01
-408	VZ353500	Ceramic Capacitor-SL	100P 50V J			01
C409	VZ353200	Ceramic Capacitor-SL	47P 50V J			01
-412	VZ353200	Ceramic Capacitor-SL	47P 50V J			01
C415	UM417100	Electrolytic Cap.	10.00 25.0V			01
-422	UM417100	Electrolytic Cap.	10.00 25.0V			01
C423	VZ353500	Ceramic Capacitor-SL	100P 50V J			01

*: New Parts

RANK : Japan only

REF NO.	PART NO.	DESCRIPTION		REMARKS	QTY	RANK
-426	VZ353500	Ceramic Capacitor-SL	100P 50V J			01
C427	VZ352700	Ceramic Capacitor-SL	10P 50V J			01
-430	VZ352700	Ceramic Capacitor-SL	10P 50V J			01
C431	VF964800	Electrolytic Cap.	100.00 16.0V			01
-434	VF964800	Electrolytic Cap.	100.00 16.0V			01
C435	UJ667470	Electrolytic Cap.	47.00 25.0V			01
C436	UJ667470	Electrolytic Cap.	47.00 25.0V			01
C437	VZ354000	Ceramic Capacitor-F	0.0100 50V Z			01
-442	VZ354000	Ceramic Capacitor-F	0.0100 50V Z			01
C443	VZ353500	Ceramic Capacitor-SL	100P 50V J			01
-448	VZ353500	Ceramic Capacitor-SL	100P 50V J			01
C449	VZ352800	Ceramic Capacitor-SL	22P 50V J			01
-454	VZ352800	Ceramic Capacitor-SL	22P 50V J			01
C455	VZ353900	Ceramic Cap.-B	1000P 50V K			01
C456	VZ353900	Ceramic Cap.-B	1000P 50V K			01
C457	UM417100	Electrolytic Cap.	10.00 25.0V			01
-468	UM417100	Electrolytic Cap.	10.00 25.0V			01
C469	VZ353500	Ceramic Capacitor-SL	100P 50V J			01
-474	VZ353500	Ceramic Capacitor-SL	100P 50V J			01
C475	VZ353200	Ceramic Capacitor-SL	47P 50V J			01
-480	VZ353200	Ceramic Capacitor-SL	47P 50V J			01
C481	UM417100	Electrolytic Cap.	10.00 25.0V			01
-486	UM417100	Electrolytic Cap.	10.00 25.0V			01
C487	VZ353000	Ceramic Capacitor-SL	33P 50V J			01
-510	VZ353000	Ceramic Capacitor-SL	33P 50V J			01
C511	VF964800	Electrolytic Cap.	100.00 16.0V			01
-522	VF964800	Electrolytic Cap.	100.00 16.0V			01
C523	UJ667470	Electrolytic Cap.	47.00 25.0V			01
-525	UJ667470	Electrolytic Cap.	47.00 25.0V			01
C526	VZ354000	Ceramic Capacitor-F	0.0100 50V Z			01
-531	VZ354000	Ceramic Capacitor-F	0.0100 50V Z			01
C532	UJ667470	Electrolytic Cap.	47.00 25.0V			01
-534	UJ667470	Electrolytic Cap.	47.00 25.0V			01
C535	VZ353600	Ceramic Cap.-B	220P 50V K			01
C536	VZ353600	Ceramic Cap.-B	220P 50V K			01
C537	VZ353500	Ceramic Capacitor-SL	100P 50V J			01
C538	VZ353500	Ceramic Capacitor-SL	100P 50V J			01
C539	VZ354000	Ceramic Capacitor-F	0.0100 50V Z			01
C540	VZ353200	Ceramic Capacitor-SL	47P 50V J			01
-543	VZ353200	Ceramic Capacitor-SL	47P 50V J			01
C544	VZ354000	Ceramic Capacitor-F	0.0100 50V Z			01
C545	VZ353500	Ceramic Capacitor-SL	100P 50V J			01
-548	VZ353500	Ceramic Capacitor-SL	100P 50V J			01
C549	VZ353200	Ceramic Capacitor-SL	47P 50V J			01
-552	VZ353200	Ceramic Capacitor-SL	47P 50V J			01
C553	VZ354000	Ceramic Capacitor-F	0.0100 50V Z			01
C554	UJ667470	Electrolytic Cap.	47.00 25.0V			01
-557	UJ667470	Electrolytic Cap.	47.00 25.0V			01
C558	VZ354000	Ceramic Capacitor-F	0.0100 50V Z			01
C559	VZ353900	Ceramic Cap.-B	1000P 50V K			01
C560	VZ353900	Ceramic Cap.-B	1000P 50V K			01
C561	UM417100	Electrolytic Cap.	10.00 25.0V			01
-566	UM417100	Electrolytic Cap.	10.00 25.0V			01
C567	VZ353500	Ceramic Capacitor-SL	100P 50V J			01
C568	VZ353500	Ceramic Capacitor-SL	100P 50V J			01
C569	VZ353200	Ceramic Capacitor-SL	47P 50V J			01
C570	VZ353200	Ceramic Capacitor-SL	47P 50V J			01
C571	VZ353500	Ceramic Capacitor-SL	100P 50V J			01
-576	VZ353500	Ceramic Capacitor-SL	100P 50V J			01
C577	UM417100	Electrolytic Cap.	10.00 25.0V			01
C578	VZ353200	Ceramic Capacitor-SL	47P 50V J			01
C579	VZ353200	Ceramic Capacitor-SL	47P 50V J			01
C580	UM417100	Electrolytic Cap.	10.00 25.0V			01
C581	VZ353500	Ceramic Capacitor-SL	100P 50V J			01
-584	VZ353500	Ceramic Capacitor-SL	100P 50V J			01
C585	VZ353200	Ceramic Capacitor-SL	47P 50V J			01
C586	UM417100	Electrolytic Cap.	10.00 25.0V			01
C587	UM417100	Electrolytic Cap.	10.00 25.0V			01
C588	VZ353500	Ceramic Capacitor-SL	100P 50V J			01
C589	VZ353200	Ceramic Capacitor-SL	47P 50V J			01

* : New Parts

RANK : Japan only

REF NO.	PART NO.	DESCRIPTION		REMARKS	QTY	RANK
C590	VZ353200	Ceramic Capacitor-SL	47P 50V J			01
C591	VZ353500	Ceramic Capacitor-SL	100P 50V J			01
C592	VZ352800	Ceramic Capacitor-SL	22P 50V J			01
C593	VF964800	Electrolytic Cap.	100.00 16.0V			01
-596	VF964800	Electrolytic Cap.	100.00 16.0V			01
C597	UM417100	Electrolytic Cap.	10.00 25.0V			01
C598	VZ353900	Ceramic Cap.-B	1000P 50V K			01
C599	VZ353900	Ceramic Cap.-B	1000P 50V K			01
C600	VZ353000	Ceramic Capacitor-SL	33P 50V J			01
-611	VZ353000	Ceramic Capacitor-SL	33P 50V J			01
C612	VZ354000	Ceramic Capacitor-F	0.0100 50V Z			01
C613	VF964800	Electrolytic Cap.	100.00 16.0V			01
C614	VZ354000	Ceramic Capacitor-F	0.0100 50V Z			01
C615	VF964800	Electrolytic Cap.	100.00 16.0V			01
-621	VF964800	Electrolytic Cap.	100.00 16.0V			01
C622	VZ354000	Ceramic Capacitor-F	0.0100 50V Z			01
-626	VZ354000	Ceramic Capacitor-F	0.0100 50V Z			01
C627	UJ667470	Electrolytic Cap.	47.00 25.0V			01
C628	VZ354000	Ceramic Capacitor-F	0.0100 50V Z			01
C629	UJ667470	Electrolytic Cap.	47.00 25.0V			01
C630	VZ354000	Ceramic Capacitor-F	0.0100 50V Z			01
C631	UJ667470	Electrolytic Cap.	47.00 25.0V			01
C632	VZ354000	Ceramic Capacitor-F	0.0100 50V Z			01
C633	UJ667470	Electrolytic Cap.	47.00 25.0V			01
C634	VZ354000	Ceramic Capacitor-F	0.0100 50V Z			01
C635	VZ354000	Ceramic Capacitor-F	0.0100 50V Z			01
C636	UM417100	Electrolytic Cap.	10.00 25.0V			01
-643	UM417100	Electrolytic Cap.	10.00 25.0V			01
C644	VZ353500	Ceramic Capacitor-F	100P 50V Z			01
-649	VZ353500	Ceramic Capacitor-F	100P 50V Z			01
C650	VZ354000	Ceramic Capacitor-F	0.0100 50V Z			01
C701	VZ354000	Ceramic Capacitor-F	0.0100 50V Z			01
C702	VZ354600	Monolithic Ceramic Cap.	0.10 50V Z			01
C703	VZ730200	Monolithic Ceramic Cap.	1.0 16V Z			01
C704	VZ730200	Monolithic Ceramic Cap.	1.0 16V Z			01
C705	VZ354600	Monolithic Ceramic Cap.	0.10 50V Z			01
C706	VZ730200	Monolithic Ceramic Cap.	1.0 16V Z			01
C707	VZ730200	Monolithic Ceramic Cap.	1.0 16V Z			01
C708	VZ354600	Monolithic Ceramic Cap.	0.10 50V Z			01
C709	VZ730200	Monolithic Ceramic Cap.	1.0 16V Z			01
C710	VZ730200	Monolithic Ceramic Cap.	1.0 16V Z			01
C711	VZ354600	Monolithic Ceramic Cap.	0.10 50V Z			01
C712	VZ730200	Monolithic Ceramic Cap.	1.0 16V Z			01
C713	VZ730200	Monolithic Ceramic Cap.	1.0 16V Z			01
C714	VZ354000	Ceramic Capacitor-F	0.0100 50V Z			01
CN101	VQ047500	Connector	52045 20P TE			01
CN102	VQ047500	Connector	52045 20P TE			01
CN104	VV066900	Connector Base Post	M2426XX 9P TE			01
CN105	VV066900	Connector Base Post	M2426XX 9P TE			01
CN107	V3098200	Connector Assembly	2426&1018 3P 60L			02
CN108	VV067700	Connector Base Post	M2426XXR 3P SE			01
CN109	VV067000	Connector Base Post	M2426XX 10P TE			01
CN110	VV066400	Connector Base Post	M2426XX 4P TE			01
CN111	VV067200	Connector Base Post	M2426XX 12P TE			01
CN112	VV066700	Connector Base Post	M2426XX 7P TE			01
CN113	VV066200	Connector Base Post	M2426XX 2P TE			01
CN114	VV066300	Connector Base Post	M2426XX 3P TE			01
CN115	VV066800	Connector Base Post	M2426XX 8P TE			01
CN116	VV066800	Connector Base Post	M2426XX 8P TE			01
D101	VD631600	Diode	1SS133,176,HSS104			01
D102	VD631600	Diode	1SS133,176,HSS104			01
D201	VD631600	Diode	1SS133,176,HSS104			01
D202	VD631600	Diode	1SS133,176,HSS104			01
IC101	XM356A00	IC	NJM2068L-D	OP AMP		02
-116	XM356A00	IC	NJM2068L-D	OP AMP		02
IC301	XM356A00	IC	NJM2068L-D	OP AMP		02
-303	XM356A00	IC	NJM2068L-D	OP AMP		02
IC401	XM356A00	IC	NJM2068L-D	OP AMP		02
IC402	XF195A00	IC	NJM4580L	OP AMP		04
IC403	XM356A00	IC	NJM2068L-D	OP AMP		02

*: New Parts

RANK : Japan only

REF NO.	PART NO.	DESCRIPTION		REMARKS	QTY	RANK
IC404	XF195A00	IC	NJM4580L	OP AMP		04
IC405	XM356A00	IC	NJM2068L-D	OP AMP		02
IC406	XM356A00	IC	NJM2068L-D	OP AMP		02
IC407	XF195A00	IC	NJM4580L	OP AMP		04
IC408	XF195A00	IC	NJM4580L	OP AMP		04
IC409	XM356A00	IC	NJM2068L-D	OP AMP		02
IC410	XM356A00	IC	NJM2068L-D	OP AMP		02
IC411	XF195A00	IC	NJM4580L	OP AMP		04
IC412	XF195A00	IC	NJM4580L	OP AMP		04
IC413	XM356A00	IC	NJM2068L-D	OP AMP		02
IC414	XM356A00	IC	NJM2068L-D	OP AMP		02
IC415	XF195A00	IC	NJM4580L	OP AMP		04
IC416	XF195A00	IC	NJM4580L	OP AMP		04
IC417	XM356A00	IC	NJM2068L-D	OP AMP		02
-422	XM356A00	IC	NJM2068L-D	OP AMP		02
IC423	XF195A00	IC	NJM4580L	OP AMP		04
-426	XF195A00	IC	NJM4580L	OP AMP		04
IC427	XP844A00	IC	NJM4556AL	OP AMP		02
IC701	VQ475400	Transistor Array	TD62003AP			02
IC702	XS046A00	IC	BA682A			06
-705	XS046A00	IC	BA682A			06
JK401	V2886000	Phone Jack	JY-6351F-06-340			02
LD101	VV620800	LED	LT311G-41-C13 RE	PEAK		01
LD201	VV620800	LED	LT311G-41-C13 RE	PEAK		01
LD701	VZ533800	LED	SLR-325VRT31(TA)RE			01
LD702	VZ533900	LED	SLR-325YYT31(TA)YE			01
-706	VZ533900	LED	SLR-325YYT31(TA)YE			01
LD707	VZ534000	LED	SLR-325MGT31(TA)GR			01
-713	VZ534000	LED	SLR-325MGT31(TA)GR			01
LD714	VZ533800	LED	SLR-325VRT31(TA)RE			01
LD715	VZ534000	LED	SLR-325MGT31(TA)GR			01
LD716	VZ533800	LED	SLR-325VRT31(TA)RE			01
LD717	VZ533900	LED	SLR-325YYT31(TA)YE			01
-721	VZ533900	LED	SLR-325YYT31(TA)YE			01
LD722	VZ534000	LED	SLR-325MGT31(TA)GR			01
-728	VZ534000	LED	SLR-325MGT31(TA)GR			01
LD729	VZ533800	LED	SLR-325VRT31(TA)RE			01
LD730	VZ533900	LED	SLR-325YYT31(TA)YE			01
-734	VZ533900	LED	SLR-325YYT31(TA)YE			01
LD735	VZ534000	LED	SLR-325MGT31(TA)GR			01
-741	VZ534000	LED	SLR-325MGT31(TA)GR			01
LD742	VZ533800	LED	SLR-325VRT31(TA)RE			01
LD743	VZ533900	LED	SLR-325YYT31(TA)YE			01
-747	VZ533900	LED	SLR-325YYT31(TA)YE			01
LD748	VZ534000	LED	SLR-325MGT31(TA)GR			01
-754	VZ534000	LED	SLR-325MGT31(TA)GR			01
Q101	IA101590	Transistor	2SA1015 O,Y			01
Q102	IC1815M0	Transistor	2SC1815 Y,GR			01
Q201	IA101590	Transistor	2SA1015 O,Y			01
Q202	IC1815M0	Transistor	2SC1815 Y,GR			01
R101	HF458220	Carbon Resistor	220.0K 1/4 J			01
-104	HF458220	Carbon Resistor	220.0K 1/4 J			01
R105	HF858100	Carbon Resistor	100.0K 1/4 J			01
R106	HF858100	Carbon Resistor	100.0K 1/4 J			01
R107	HF457100	Carbon Resistor	10.0K 1/4 J			01
R108	HF457100	Carbon Resistor	10.0K 1/4 J			01
R109	HF456220	Carbon Resistor	2.2K 1/4 J			01
R110	HF456220	Carbon Resistor	2.2K 1/4 J			01
R111	HF455220	Carbon Resistor	220.0 1/4 J			01
R112	HF455220	Carbon Resistor	220.0 1/4 J			01
R113	HF454390	Carbon Resistor	39.0 1/4 J			01
R114	HF454390	Carbon Resistor	39.0 1/4 J			01
R115	HF457150	Carbon Resistor	15.0K 1/4 J			01
R116	HF457150	Carbon Resistor	15.0K 1/4 J			01
R117	HF458220	Carbon Resistor	220.0K 1/4 J			01
R118	HF458220	Carbon Resistor	220.0K 1/4 J			01
R119	HF457150	Carbon Resistor	15.0K 1/4 J			01
R120	HF457150	Carbon Resistor	15.0K 1/4 J			01
R121	HF457300	Carbon Resistor	30.0K 1/4 J			01
R122	HF457300	Carbon Resistor	30.0K 1/4 J			01

* : New Parts

RANK : Japan only

REF NO.	PART NO.	DESCRIPTION	REMARKS	QTY	RANK
R123	HF454470	Carbon Resistor	47.0 1/4 J		01
R124	HF454470	Carbon Resistor	47.0 1/4 J		01
R125	HF458220	Carbon Resistor	220.0K 1/4 J		01
-130	HF458220	Carbon Resistor	220.0K 1/4 J		01
R131	HF457100	Carbon Resistor	10.0K 1/4 J		01
R132	HF456470	Carbon Resistor	4.7K 1/4 J		01
R133	HF457100	Carbon Resistor	10.0K 1/4 J		01
R134	HF456470	Carbon Resistor	4.7K 1/4 J		01
R135	HF457330	Carbon Resistor	33.0K 1/4 J		01
R136	HF457100	Carbon Resistor	10.0K 1/4 J		01
R137	HF457330	Carbon Resistor	33.0K 1/4 J		01
R138	HF457100	Carbon Resistor	10.0K 1/4 J		01
R139	HF856560	Carbon Resistor	5.6K 1/4 J		01
R140	HF856560	Carbon Resistor	5.6K 1/4 J		01
R141	HF457180	Carbon Resistor	18.0K 1/4 J		01
R142	HF456820	Carbon Resistor	8.2K 1/4 J		01
R143	HF456820	Carbon Resistor	8.2K 1/4 J		01
R144	HF457180	Carbon Resistor	18.0K 1/4 J		01
-146	HF457180	Carbon Resistor	18.0K 1/4 J		01
R147	HF456820	Carbon Resistor	8.2K 1/4 J		01
R148	HF456820	Carbon Resistor	8.2K 1/4 J		01
R149	HF454100	Carbon Resistor	10.0 1/4 J		01
R150	HF454100	Carbon Resistor	10.0 1/4 J		01
R151	HF458220	Carbon Resistor	220.0K 1/4 J		01
R152	HF458220	Carbon Resistor	220.0K 1/4 J		01
R153	HF858100	Carbon Resistor	100.0K 1/4 J		01
R154	HF457100	Carbon Resistor	10.0K 1/4 J		01
R155	HF858100	Carbon Resistor	100.0K 1/4 J		01
R156	HF456470	Carbon Resistor	4.7K 1/4 J		01
R157	HF456330	Carbon Resistor	3.3K 1/4 J		01
R158	HF455220	Carbon Resistor	220.0 1/4 J		01
R159	HF455220	Carbon Resistor	220.0 1/4 J		01
R160	HF858100	Carbon Resistor	100.0K 1/4 J		01
R161	HF457180	Carbon Resistor	18.0K 1/4 J		01
R162	HF457180	Carbon Resistor	18.0K 1/4 J		01
R163	HF455220	Carbon Resistor	220.0 1/4 J		01
R164	HF455220	Carbon Resistor	220.0 1/4 J		01
R165	HF456470	Carbon Resistor	4.7K 1/4 J		01
R166	HF456470	Carbon Resistor	4.7K 1/4 J		01
R167	HF457100	Carbon Resistor	10.0K 1/4 J		01
R168	HF457100	Carbon Resistor	10.0K 1/4 J		01
R169	HF454100	Carbon Resistor	10.0 1/4 J		01
R170	HF454100	Carbon Resistor	10.0 1/4 J		01
R171	HF458220	Carbon Resistor	220.0K 1/4 J		01
R172	HF458220	Carbon Resistor	220.0K 1/4 J		01
R173	HF457220	Carbon Resistor	22.0K 1/4 J		01
-176	HF457220	Carbon Resistor	22.0K 1/4 J		01
R177	HF457150	Carbon Resistor	15.0K 1/4 J		01
-182	HF457150	Carbon Resistor	15.0K 1/4 J		01
R183	HF454470	Carbon Resistor	47.0 1/4 J		01
R184	HF454470	Carbon Resistor	47.0 1/4 J		01
R185	HF458220	Carbon Resistor	220.0K 1/4 J		01
R186	HF457180	Carbon Resistor	18.0K 1/4 J		01
-199	HF457180	Carbon Resistor	18.0K 1/4 J		01
R201	HF458220	Carbon Resistor	220.0K 1/4 J		01
-204	HF458220	Carbon Resistor	220.0K 1/4 J		01
R205	HF858100	Carbon Resistor	100.0K 1/4 J		01
R206	HF858100	Carbon Resistor	100.0K 1/4 J		01
R207	HF457100	Carbon Resistor	10.0K 1/4 J		01
R208	HF457100	Carbon Resistor	10.0K 1/4 J		01
R209	HF456220	Carbon Resistor	2.2K 1/4 J		01
R210	HF456220	Carbon Resistor	2.2K 1/4 J		01
R211	HF455220	Carbon Resistor	220.0 1/4 J		01
R212	HF455220	Carbon Resistor	220.0 1/4 J		01
R213	HF454390	Carbon Resistor	39.0 1/4 J		01
R214	HF454390	Carbon Resistor	39.0 1/4 J		01
R215	HF457150	Carbon Resistor	15.0K 1/4 J		01
R216	HF457150	Carbon Resistor	15.0K 1/4 J		01
R217	HF458220	Carbon Resistor	220.0K 1/4 J		01
R218	HF458220	Carbon Resistor	220.0K 1/4 J		01

*: New Parts

RANK : Japan only

REF NO.	PART NO.	DESCRIPTION		REMARKS	QTY	RANK
R219	HF457150	Carbon Resistor	15.0K 1/4 J			01
R220	HF457150	Carbon Resistor	15.0K 1/4 J			01
R221	HF457300	Carbon Resistor	30.0K 1/4 J			01
R222	HF457300	Carbon Resistor	30.0K 1/4 J			01
R223	HF454470	Carbon Resistor	47.0 1/4 J			01
R224	HF454470	Carbon Resistor	47.0 1/4 J			01
R225	HF458220	Carbon Resistor	220.0K 1/4 J			01
-230	HF458220	Carbon Resistor	220.0K 1/4 J			01
R231	HF457100	Carbon Resistor	10.0K 1/4 J			01
R232	HF456470	Carbon Resistor	4.7K 1/4 J			01
R233	HF457100	Carbon Resistor	10.0K 1/4 J			01
R234	HF456470	Carbon Resistor	4.7K 1/4 J			01
R235	HF457330	Carbon Resistor	33.0K 1/4 J			01
R236	HF457100	Carbon Resistor	10.0K 1/4 J			01
R237	HF457330	Carbon Resistor	33.0K 1/4 J			01
R238	HF457100	Carbon Resistor	10.0K 1/4 J			01
R239	HF856560	Carbon Resistor	5.6K 1/4 J			01
R240	HF856560	Carbon Resistor	5.6K 1/4 J			01
R241	HF457180	Carbon Resistor	18.0K 1/4 J			01
R242	HF456820	Carbon Resistor	8.2K 1/4 J			01
R243	HF456820	Carbon Resistor	8.2K 1/4 J			01
R244	HF457180	Carbon Resistor	18.0K 1/4 J			01
-246	HF457180	Carbon Resistor	18.0K 1/4 J			01
R247	HF456820	Carbon Resistor	8.2K 1/4 J			01
R248	HF456820	Carbon Resistor	8.2K 1/4 J			01
R249	HF454100	Carbon Resistor	10.0 1/4 J			01
R250	HF454100	Carbon Resistor	10.0 1/4 J			01
R251	HF458220	Carbon Resistor	220.0K 1/4 J			01
R252	HF458220	Carbon Resistor	220.0K 1/4 J			01
R253	HF858100	Carbon Resistor	100.0K 1/4 J			01
R254	HF457100	Carbon Resistor	10.0K 1/4 J			01
R255	HF858100	Carbon Resistor	100.0K 1/4 J			01
R256	HF456470	Carbon Resistor	4.7K 1/4 J			01
R257	HF456330	Carbon Resistor	3.3K 1/4 J			01
R258	HF455220	Carbon Resistor	220.0 1/4 J			01
R259	HF455220	Carbon Resistor	220.0 1/4 J			01
R260	HF858100	Carbon Resistor	100.0K 1/4 J			01
R261	HF457180	Carbon Resistor	18.0K 1/4 J			01
R262	HF457180	Carbon Resistor	18.0K 1/4 J			01
R263	HF455220	Carbon Resistor	220.0 1/4 J			01
R264	HF455220	Carbon Resistor	220.0 1/4 J			01
R265	HF456470	Carbon Resistor	4.7K 1/4 J			01
R266	HF456470	Carbon Resistor	4.7K 1/4 J			01
R267	HF457100	Carbon Resistor	10.0K 1/4 J			01
R268	HF457100	Carbon Resistor	10.0K 1/4 J			01
R269	HF454100	Carbon Resistor	10.0 1/4 J			01
R270	HF454100	Carbon Resistor	10.0 1/4 J			01
R271	HF458220	Carbon Resistor	220.0K 1/4 J			01
R272	HF458220	Carbon Resistor	220.0K 1/4 J			01
R273	HF457220	Carbon Resistor	22.0K 1/4 J			01
-276	HF457220	Carbon Resistor	22.0K 1/4 J			01
R277	HF457150	Carbon Resistor	15.0K 1/4 J			01
-282	HF457150	Carbon Resistor	15.0K 1/4 J			01
R283	HF454470	Carbon Resistor	47.0 1/4 J			01
R284	HF454470	Carbon Resistor	47.0 1/4 J			01
R285	HF458220	Carbon Resistor	220.0K 1/4 J			01
R286	HF457180	Carbon Resistor	18.0K 1/4 J			01
-299	HF457180	Carbon Resistor	18.0K 1/4 J			01
R301	HF457100	Carbon Resistor	10.0K 1/4 J			01
-305	HF457100	Carbon Resistor	10.0K 1/4 J			01
R306	HF455100	Carbon Resistor	100.0 1/4 J			01
R307	HF455100	Carbon Resistor	100.0 1/4 J			01
R308	HF457100	Carbon Resistor	10.0K 1/4 J			01
-310	HF457100	Carbon Resistor	10.0K 1/4 J			01
R311	HF457220	Carbon Resistor	22.0K 1/4 J			01
R312	HF457220	Carbon Resistor	22.0K 1/4 J			01
R313	HF454220	Carbon Resistor	22.0 1/4 J			01
-316	HF454220	Carbon Resistor	22.0 1/4 J			01
R317	HF455100	Carbon Resistor	100.0 1/4 J			01
R318	HF455100	Carbon Resistor	100.0 1/4 J			01

* : New Parts

RANK : Japan only

REF NO.	PART NO.	DESCRIPTION	REMARKS	QTY	RANK
R319	HF457100	Carbon Resistor	10.0K 1/4 J		01
-322	HF457100	Carbon Resistor	10.0K 1/4 J		01
R323	HF457150	Carbon Resistor	15.0K 1/4 J		01
R324	HF457150	Carbon Resistor	15.0K 1/4 J		01
R325	HF457220	Carbon Resistor	22.0K 1/4 J		01
R326	HF457220	Carbon Resistor	22.0K 1/4 J		01
R327	HF457100	Carbon Resistor	10.0K 1/4 J		01
-330	HF457100	Carbon Resistor	10.0K 1/4 J		01
R331	HF454220	Carbon Resistor	22.0 1/4 J		01
-334	HF454220	Carbon Resistor	22.0 1/4 J		01
R335	HF456820	Carbon Resistor	8.2K 1/4 J		01
R336	HF456820	Carbon Resistor	8.2K 1/4 J		01
R337	HF457150	Carbon Resistor	15.0K 1/4 J		01
-342	HF457150	Carbon Resistor	15.0K 1/4 J		01
R343	HF457300	Carbon Resistor	30.0K 1/4 J		01
-348	HF457300	Carbon Resistor	30.0K 1/4 J		01
R349	HF457150	Carbon Resistor	15.0K 1/4 J		01
R350	HF457150	Carbon Resistor	15.0K 1/4 J		01
R351	HF457300	Carbon Resistor	30.0K 1/4 J		01
R352	HF457300	Carbon Resistor	30.0K 1/4 J		01
R353	HF456510	Carbon Resistor	5.1K 1/4 J		01
-360	HF456510	Carbon Resistor	5.1K 1/4 J		01
R361	HF454220	Carbon Resistor	22.0 1/4 J		01
-364	HF454220	Carbon Resistor	22.0 1/4 J		01
R365	HF456510	Carbon Resistor	5.1K 1/4 J		01
-372	HF456510	Carbon Resistor	5.1K 1/4 J		01
R401	HF457330	Carbon Resistor	33.0K 1/4 J		01
-416	HF457330	Carbon Resistor	33.0K 1/4 J		01
R417	HF457180	Carbon Resistor	18.0K 1/4 J		01
-420	HF457180	Carbon Resistor	18.0K 1/4 J		01
R421	HF457120	Carbon Resistor	12.0K 1/4 J		01
-424	HF457120	Carbon Resistor	12.0K 1/4 J		01
R425	HF457680	Carbon Resistor	68.0K 1/4 J		01
-428	HF457680	Carbon Resistor	68.0K 1/4 J		01
R429	HF454750	Carbon Resistor	75.0 1/4 J		01
R430	HF858100	Carbon Resistor	100.0K 1/4 J		01
R431	HF454750	Carbon Resistor	75.0 1/4 J		01
R432	HF858100	Carbon Resistor	100.0K 1/4 J		01
R433	HF454750	Carbon Resistor	75.0 1/4 J		01
R434	HF858100	Carbon Resistor	100.0K 1/4 J		01
R435	HF454750	Carbon Resistor	75.0 1/4 J		01
R436	HF858100	Carbon Resistor	100.0K 1/4 J		01
R437	HF457100	Carbon Resistor	10.0K 1/4 J		01
-448	HF457100	Carbon Resistor	10.0K 1/4 J		01
R449	HF457360	Carbon Resistor	36.0K 1/4 J		01
-454	HF457360	Carbon Resistor	36.0K 1/4 J		01
R455	HF457180	Carbon Resistor	18.0K 1/4 J		01
-460	HF457180	Carbon Resistor	18.0K 1/4 J		01
R461	HF457100	Carbon Resistor	10.0K 1/4 J		01
-466	HF457100	Carbon Resistor	10.0K 1/4 J		01
R467	HF458220	Carbon Resistor	220.0K 1/4 J		01
-472	HF458220	Carbon Resistor	220.0K 1/4 J		01
R473	VV065500	Metal Film Resistor	10K 1/4 F		01
R474	VV065600	Metal Film Resistor	11K 1/4 F		05
R475	VV065500	Metal Film Resistor	10K 1/4 F		01
R476	VV065600	Metal Film Resistor	11K 1/4 F		05
R477	VV065500	Metal Film Resistor	10K 1/4 F		01
R478	VV065600	Metal Film Resistor	11K 1/4 F		05
R479	VV065500	Metal Film Resistor	10K 1/4 F		01
R480	VV065600	Metal Film Resistor	11K 1/4 F		05
R481	VV065500	Metal Film Resistor	10K 1/4 F		01
R482	VV065600	Metal Film Resistor	11K 1/4 F		05
R483	VV065500	Metal Film Resistor	10K 1/4 F		01
R484	VV065600	Metal Film Resistor	11K 1/4 F		05
R485	VV065500	Metal Film Resistor	10K 1/4 F		01
-502	VV065700	Metal Film Resistor	18K 1/4 F		
R503	VV065800	Metal Film Resistor	20K 1/4 F		05
-514	VV065800	Metal Film Resistor	20K 1/4 F		05
R515	VV065700	Metal Film Resistor	18K 1/4 F		
-520	VV065700	Metal Film Resistor	18K 1/4 F		

*: New Parts

RANK : Japan only

REF NO.	PART NO.	DESCRIPTION		REMARKS	QTY	RANK
R521	HF454750	Carbon Resistor	75.0 1/4 J			01
-532	HF454750	Carbon Resistor	75.0 1/4 J			01
R533	HF858100	Carbon Resistor	100.0K 1/4 J			01
-544	HF858100	Carbon Resistor	100.0K 1/4 J			01
R545	HF457180	Carbon Resistor	18.0K 1/4 J			01
-550	HF457180	Carbon Resistor	18.0K 1/4 J			01
R551	HF457100	Carbon Resistor	10.0K 1/4 J			01
R558	HF457100	Carbon Resistor	10.0K 1/4 J			01
R559	HF454100	Carbon Resistor	10.0 1/4 J			01
-562	HF454100	Carbon Resistor	10.0 1/4 J			01
R563	HF858100	Carbon Resistor	100.0K 1/4 J			01
-567	HF858100	Carbon Resistor	100.0K 1/4 J			01
R569	HF457220	Carbon Resistor	22.0K 1/4 J			01
R570	HF457220	Carbon Resistor	22.0K 1/4 J			01
R571	HF455220	Carbon Resistor	220.0 1/4 J			01
R572	HF455220	Carbon Resistor	220.0 1/4 J			01
R573	HF457180	Carbon Resistor	18.0K 1/4 J			01
R574	HF457180	Carbon Resistor	18.0K 1/4 J			01
R575	HF455220	Carbon Resistor	220.0 1/4 J			01
-580	HF455220	Carbon Resistor	220.0 1/4 J			01
R581	HF457150	Carbon Resistor	15.0K 1/4 J			01
R582	HF457180	Carbon Resistor	18.0K 1/4 J			01
R583	HF456430	Carbon Resistor	4.3K 1/4 J			01
R584	HF456430	Carbon Resistor	4.3K 1/4 J			01
R585	HF457180	Carbon Resistor	18.0K 1/4 J			01
-587	HF457180	Carbon Resistor	18.0K 1/4 J			01
R588	HF455220	Carbon Resistor	220.0 1/4 J			01
-591	HF455220	Carbon Resistor	220.0 1/4 J			01
R592	HF457100	Carbon Resistor	10.0K 1/4 J			01
R593	HF457100	Carbon Resistor	10.0K 1/4 J			01
R594	HF456470	Carbon Resistor	4.7K 1/4 J			01
R595	HF456430	Carbon Resistor	4.3K 1/4 J			01
R596	HF456430	Carbon Resistor	4.3K 1/4 J			01
R597	HF456470	Carbon Resistor	4.7K 1/4 J			01
R598	HF454100	Carbon Resistor	10.0 1/4 J			01
R599	HF454100	Carbon Resistor	10.0 1/4 J			01
R600	HF457180	Carbon Resistor	18.0K 1/4 J			01
R601	HF457100	Carbon Resistor	10.0K 1/4 J			01
R602	HF457110	Carbon Resistor	11.0K 1/4 J			01
R603	HF457110	Carbon Resistor	11.0K 1/4 J			01
R604	HF457100	Carbon Resistor	10.0K 1/4 J			01
R605	HF458220	Carbon Resistor	220.0K 1/4 J			01
R606	HF458220	Carbon Resistor	220.0K 1/4 J			01
R607	HF457360	Carbon Resistor	36.0K 1/4 J			01
R608	HF454100	Carbon Resistor	10.0 1/4 J			01
R609	HF454750	Carbon Resistor	75.0 1/4 J			01
R610	HF454750	Carbon Resistor	75.0 1/4 J			01
R611	HF455220	Carbon Resistor	220.0 1/4 J			01
-614	HF455220	Carbon Resistor	220.0 1/4 J			01
R615	HF858100	Carbon Resistor	100.0K 1/4 J			01
-617	HF858100	Carbon Resistor	100.0K 1/4 J			01
R618	HF458220	Carbon Resistor	220.0K 1/4 J			01
R619	HF858100	Carbon Resistor	100.0K 1/4 J			01
R620	VV065500	Metal Film Resistor	10K 1/4 F			01
-626	VV065500	Metal Film Resistor	10K 1/4 F			01
R627	VV065600	Metal Film Resistor	11K 1/4 F			05
R628	VV065500	Metal Film Resistor	10K 1/4 F			01
R629	VV065600	Metal Film Resistor	11K 1/4 F			05
R630	VV065500	Metal Film Resistor	10K 1/4 F			01
R631	VV065600	Metal Film Resistor	11K 1/4 F			05
R632	VV065800	Metal Film Resistor	20K 1/4 F			05
R633	VV065800	Metal Film Resistor	20K 1/4 F			05
R634	VV065700	Metal Film Resistor	18K 1/4 F			
R635	VV065700	Metal Film Resistor	18K 1/4 F			
R636	VV065800	Metal Film Resistor	20K 1/4 F			05
R637	VV065800	Metal Film Resistor	20K 1/4 F			05
R638	VV065700	Metal Film Resistor	18K 1/4 F			
R639	VV065800	Metal Film Resistor	20K 1/4 F			05
R640	VV065800	Metal Film Resistor	20K 1/4 F			05
R641	VV065700	Metal Film Resistor	18K 1/4 F			

* : New Parts

RANK : Japan only

REF NO.	PART NO.	DESCRIPTION		REMARKS	QTY	RANK
-643	VV065700	Metal Film Resistor	18K 1/4 F			
R644	VV058500	Flame Proof C. Resistor	10.0 1/4 J			01
R645	HF454750	Carbon Resistor	75.0 1/4 J			01
-650	HF454750	Carbon Resistor	75.0 1/4 J			01
R651	VV058500	Flame Proof C. Resistor	10.0 1/4 J			01
R652	HF858100	Carbon Resistor	100.0K 1/4 J			01
-658	HF858100	Carbon Resistor	100.0K 1/4 J			01
R659	HF457220	Carbon Resistor	22.0K 1/4 J			01
-662	HF457220	Carbon Resistor	22.0K 1/4 J			01
R663	HF455220	Carbon Resistor	220.0K 1/4 J			01
-674	HF455220	Carbon Resistor	220.0K 1/4 J			01
R675	HF456430	Carbon Resistor	4.3K 1/4 J			01
-680	HF456430	Carbon Resistor	4.3K 1/4 J			01
R701	HF456100	Carbon Resistor	1.0K 1/4 J			01
R702	HF455470	Carbon Resistor	470.0 1/4 J			01
R703	HF458470	Carbon Resistor	470.0K 1/4 J			01
R704	HF455150	Carbon Resistor	150.0 1/4 J			01
R705	HF456330	Carbon Resistor	3.3K 1/4 J			01
R706	HF457560	Carbon Resistor	56.0K 1/4 J			01
R707	HF457100	Carbon Resistor	10.0K 1/4 J			01
R708	HF457360	Carbon Resistor	36.0K 1/4 J			01
R709	HF458220	Carbon Resistor	220.0K 1/4 J			01
R710	HF457470	Carbon Resistor	47.0K 1/4 J			01
R711	HF456100	Carbon Resistor	1.0K 1/4 J			01
R712	HF456330	Carbon Resistor	3.3K 1/4 J			01
R713	HF455470	Carbon Resistor	470.0 1/4 J			01
R714	HF458470	Carbon Resistor	470.0K 1/4 J			01
R715	HF455150	Carbon Resistor	150.0 1/4 J			01
R716	HF457560	Carbon Resistor	56.0K 1/4 J			01
R717	HF457100	Carbon Resistor	10.0K 1/4 J			01
R718	HF457360	Carbon Resistor	36.0K 1/4 J			01
R719	HF458220	Carbon Resistor	220.0K 1/4 J			01
R720	HF457470	Carbon Resistor	47.0K 1/4 J			01
R721	HF456100	Carbon Resistor	1.0K 1/4 J			01
R722	HF455470	Carbon Resistor	470.0 1/4 J			01
R723	HF458470	Carbon Resistor	470.0K 1/4 J			01
R724	HF455150	Carbon Resistor	150.0 1/4 J			01
R725	HF457560	Carbon Resistor	56.0K 1/4 J			01
R726	HF457100	Carbon Resistor	10.0K 1/4 J			01
R727	HF457360	Carbon Resistor	36.0K 1/4 J			01
R728	HF458220	Carbon Resistor	220.0K 1/4 J			01
R729	HF457470	Carbon Resistor	47.0K 1/4 J			01
R730	HF456100	Carbon Resistor	1.0K 1/4 J			01
R731	HF455470	Carbon Resistor	470.0 1/4 J			01
R732	HF458470	Carbon Resistor	470.0K 1/4 J			01
R733	HF455150	Carbon Resistor	150.0 1/4 J			01
R734	HF457560	Carbon Resistor	56.0K 1/4 J			01
R735	HF457100	Carbon Resistor	10.0K 1/4 J			01
R736	HF457360	Carbon Resistor	36.0K 1/4 J			01
R737	HF458220	Carbon Resistor	220.0K 1/4 J			01
R738	HF457470	Carbon Resistor	47.0K 1/4 J			01
SW101	VZ587700	Push Switch		A/B,HPF,PRE3-4,PRE5-6,		01
-108	VZ587700	Push Switch		1-2,3-4,ST,PFL		01
SW109	VZ251800	Push Switch	ESB68149	ON		03
SW201	VZ587700	Push Switch		A/B,HPF,PRE3-4,PRE5-6,		01
-208	VZ587700	Push Switch		1-2,3-4,ST,PFL		01
SW209	VZ251800	Push Switch	ESB68149	ON		03
SW301	VZ587700	Push Switch		PFL(AUX RETURN 1/2),		01
-303	VZ587700	Push Switch		TAPE IN ON		01
SW401	VZ587700	Push Switch		AFL(AUX1-6,GROUP1-4,		01
-417	VZ587700	Push Switch		STEREO),TAPE IN,POST		01
				(STEREO),TO ST(GROUP1-4)		
SW418	VZ251800	Push Switch	ESB68149	METER SELECT		03
SW419	VV051500	Slide Switch	SSSU012NB1-YL	PHANTOM ON/OFF		02
* VR101	VZ611000	Rotary Variable Resistor	C 20K RK12L123	GAIN		
VR102	VZ611100	Rotary Variable Resistor	B 50K RK12L123	LOW		05
VR103	VZ611100	Rotary Variable Resistor	B 50K RK12L123	HIGH		05
* VR104	VZ611300	Rotary Variable Resistor	W 20K RK12L123	MID		
VR105	VU804200	Slide Variable Resistor	RS60112G6039-10KA2	Fader		05
VR106	VZ610800	Rotary Variable Resistor	AC 20K RK12L123	BAL		03

*: New Parts

RANK : Japan only

REF NO.	PART NO.	DESCRIPTION		REMARKS	QTY	RANK
VR107	VU804600	Rotary Variable Resistor	A 20.0K RK09K113	A1-A6		04
-112	VU804600	Rotary Variable Resistor	A 20.0K RK09K113			04
* VR201	VZ611000	Rotary Variable Resistor	C 20K RK12L123	GAIN		
VR202	VZ611100	Rotary Variable Resistor	B 50K RK12L123	LOW		05
VR203	VZ611100	Rotary Variable Resistor	B 50K RK12L123	HIGH		05
* VR204	VZ611300	Rotary Variable Resistor	W 20K RK12L123	MID		
VR205	VU804200	Slide Variable Resistor	RS60112G6039-10KA2	Fader		05
VR206	VZ610800	Rotary Variable Resistor	AC 20K RK12L123	BAL		03
VR207	VU804600	Rotary Variable Resistor	A 20.0K RK09K113	A1-A6		04
-212	VU804600	Rotary Variable Resistor	A 20.0K RK09K113			04
VR301	VZ610900	Rotary Variable Resistor	A 20K RK12L12C	ST(AUX RETURN1/2, TAPE IN)		02
-303	VZ610900	Rotary Variable Resistor	A 20K RK12L12C			02
VR304	VU804600	Rotary Variable Resistor	A 20.0K RK09K113	GROUP1-4,AUX1-4		04
-311	VU804600	Rotary Variable Resistor	A 20.0K RK09K113			04
VR401	VU804100	Slide Variable Resistor	RS6011YG6036-10KA	GROUP1-4		04
-404	VU804100	Slide Variable Resistor	RS6011YG6036-10KA			04
VR405	VZ610800	Rotary Variable Resistor	AC 20K RK12L123	PAN(GROUP1-4)		03
-408	VZ610800	Rotary Variable Resistor	AC 20K RK12L123			03
VR409	VU804100	Slide Variable Resistor	RS6011YG6036-10KA	Fader(AUX1-6)		04
-414	VU804100	Slide Variable Resistor	RS6011YG6036-10KA			04
VR415	VU804200	Slide Variable Resistor	RS60112G6039-10KA2	Fader(STEREO)		05
VR416	VZ610900	Rotary Variable Resistor	A 20K RK12L12C	C-R MONI LEVEL		02
VR417	VZ610900	Rotary Variable Resistor	A 20K RK12L12C	PHONES LEVEL		02
VR418	VU804600	Rotary Variable Resistor	A 20.0K RK09K113	MONO		04
ZD701	VG443700	Zener Diode	MTZ J 33.0B 33.0V			01

* : New Parts

RANK : Japan only